

# ANDERSEN

QUALITY MEETS DESIGN



## SPACE MEETING TABLES

Design: Andersen Design Team



## SPACE – A FUNCTIONAL RANGE OF MEETING TABLES WITH A CLEAN SCANDINAVIAN LOOK

Space is a functional range of meeting tables designed by the Andersen Design Team. The range consists of tables in several heights and widths, as well as round tables. The elegant base is available in black lacquered oak, clear lacquered oak, or white pigmented lacquered oak, and the tabletop is available in many colours. This maximises the options for creating exactly the table that fits into your context, whether it's for use as a meeting table, in an office, or in another public space.

With a standard total length of up to 480 cm, the Space table is ideal for rooms which call for extra length and gravitas. Available in widths of 120 cm or 140 cm. The longest standard tables are available in a width of 160 cm. Uniquely, the table maintains its stability regardless of its size. Its construction means that the table only requires a few bases despite its length. Cable covers and power solutions can be added to Space, giving you a practical and attractive solution.

### PRODUCT HIGHLIGHTS

- Large selection of heights, widths and formats
- Available in lengths up to 480 cm as standard
- Available in widths up to 160 cm as standard
- Custom sizes available
- Tabletop options in many colours
- Elegant Scandinavian design and look
- Option for integrated cable covers and power solutions

# SPACE MEETING TABLES

Design: Andersen Design Team



## DIMENSIONS

SPACE // Height 74 cm

Length	Width	Height
180 cm	90 cm	74 cm
220 cm	90 cm	74 cm
220 cm	120 cm	74 cm
240 cm	120 cm	74 cm
295 cm	120 cm	74 cm

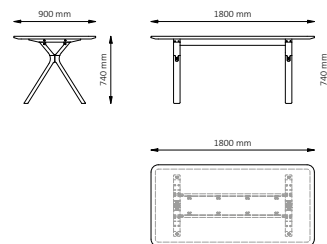

SPACE // Height 93 cm

Length	Width	Height
160 cm	70 cm	93 cm
160 cm	80 cm	93 cm
220 cm	70 cm	93 cm
220 cm	80 cm	93 cm
275 cm	70 cm	93 cm
275 cm	80 cm	93 cm

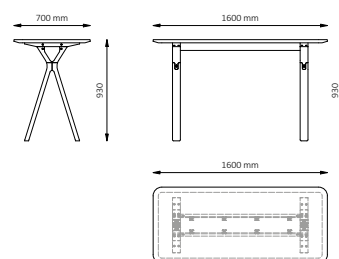

SPACE // Height 108 cm

Length	Width	Height
160 cm	70 cm	108 cm
160 cm	80 cm	108 cm
220 cm	70 cm	108 cm
220 cm	80 cm	108 cm
275 cm	70 cm	108 cm
275 cm	80 cm	108 cm

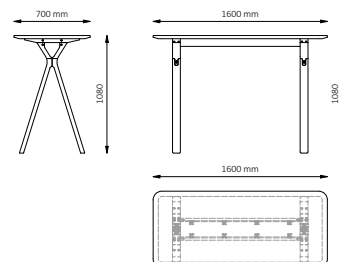

# SPACE MEETING TABLES

Design: Andersen Design Team



## DIMENSIONS

### SPACE // 2 tabletops - 3 legs/frame

Length	Width	Height
360 cm	120 cm	74 cm
420 cm	120 cm	74 cm

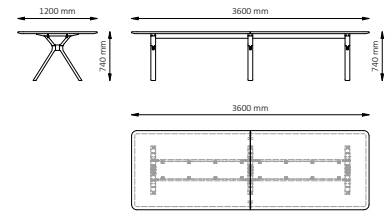

### SPACE // 2 tabletops - 4 legs/frame

Length	Width	Height
480 cm	120 cm	74 cm

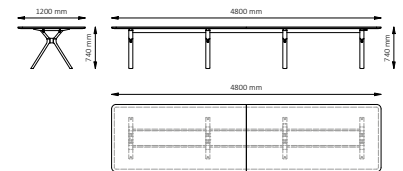

### SPACE // 3 tabletops - 3 legs/frame

Length	Width	Height
360 cm	140 cm	74 cm
360 cm	160 cm	74 cm

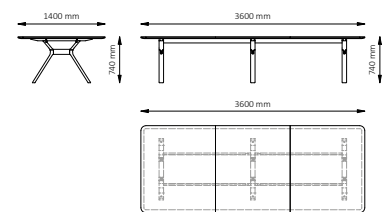

### SPACE // 4 tabletops - 3 legs/frame

Length	Width	Height
420 cm	140 cm	74 cm
420 cm	160 cm	74 cm

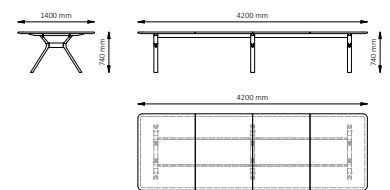

### SPACE // 4 tabletops - 4 legs/frame

Length	Width	Height
480 cm	140 cm	74 cm
480 cm	160 cm	74 cm

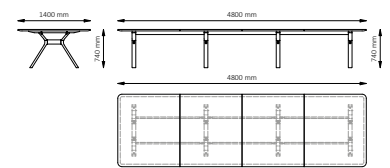

# SPACE MEETING TABLES

Design: Andersen Design Team



## DIMENSIONS

SPACE // Round	Width	Height
3 legs/frame	Ø90 cm	74 cm
4 legs/frame	Ø110 cm	74 cm
4 legs/frame	Ø120 cm	74 cm
2 pieces / 4 legs	Ø140 cm	74 cm

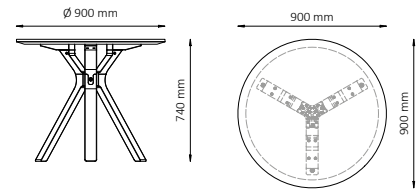

SPACE // Round	Width	Height
	Ø75 cm	93 cm
	Ø90 cm	93 cm

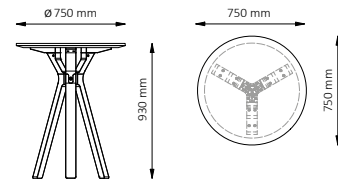

SPACE // Round	Width	Height
	Ø75 cm	108 cm
	Ø90 cm	108 cm

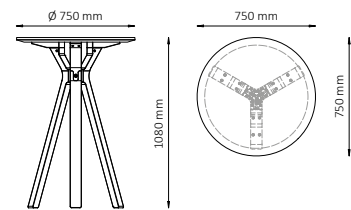

# SPACE MEETING TABLES

Design: Andersen Design Team



## TABLETOP

White laminate (Alpino) is standard - For an additional fee it is possible to have oak veneer, Fenix laminate and linoleum in other colours - available on request.

The tabletop in laminate, FENIX laminate and linoleum is a 28 mm MDF sheet.

## TABLE TOP - OAK VENEER

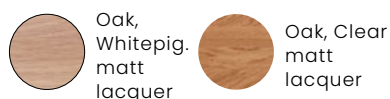

## COLOURED LAMINATE (HPL)



## FENIX COLOURS



## LINOLEUM COLOURS



# SPACE MEETING TABLES

Design: Andersen Design Team



## LEGS



Oak, black lacquered



Oak, whitepigmented  
matt lacquer



Oak, clear matt lacquer

## RAIL

The rail is made of solid black wood.

## TABLETOP EGDE

Edge / Painted edge: The veneer tables have edge banding in oak veneer included.

The edge on the laminate and linoleum tables is, as a standard, bevelled and black painted.

Edge with oak veneer banding - additional fee.

## FEATURES / ACCESSORIES

### Cable Cover

There is the option to install a cable cover into the Tabletop. Choose between two types of covers with different surfaces. In addition, it is possible to have a cable tray for mounting under the cable cover.

### Cable Cover

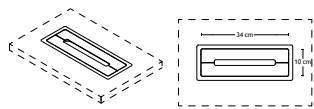

Flip cover

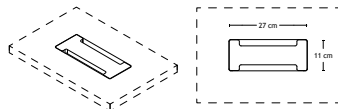

Drop-In



Drop-In

### Flip cover

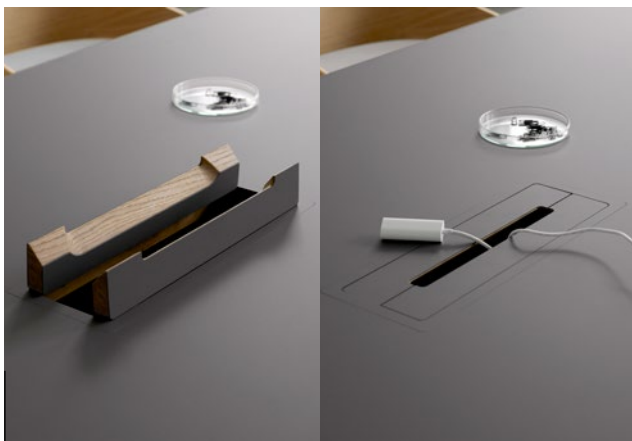

### Cable tray

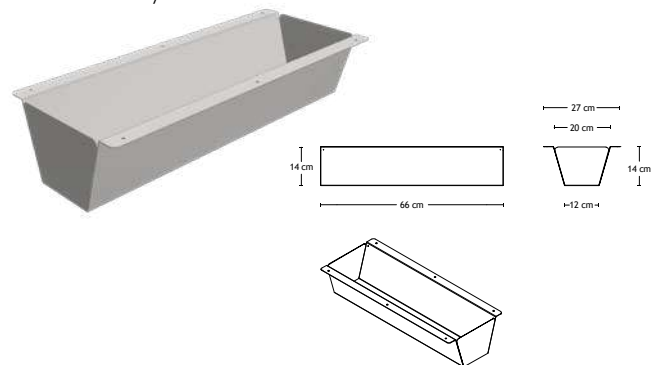

Cable tray for installation  
underneath the cable cover.

# SPACE TABLES

Design: Andersen Design Team