

Captain's Chair

© design by Metrica

extremis®



Dimensions

The Captain's sliding Chair is available in one dimension

The Captain's high sliding Chair is available in one dimension

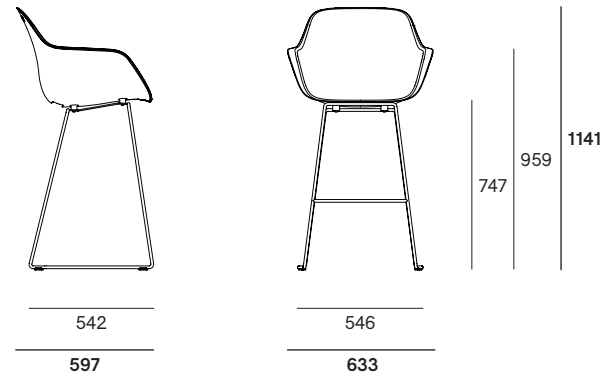
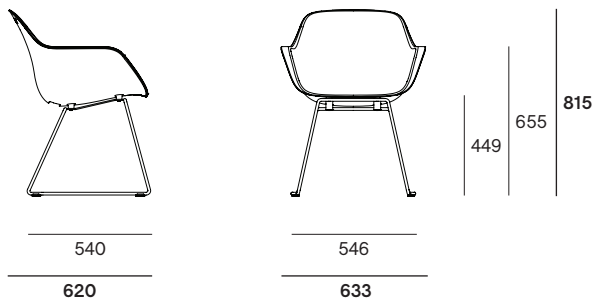

Box dimensions

The Captain's sliding Chairs come in 2 boxes

Max. 6 shells per box: 0,29 m³ | Gross weight: 27,20 kg | Net weight: 24,00 kg

Max. 6 sliding legs per box: 0,18 m³ | Gross weight: 24,40 kg | Net weight: 21,00 kg

Max. 2 high sliding legs per box: 0,27 m³ | Gross weight: 13,80 kg | Net weight: 10,40 kg

Box 1: Shell

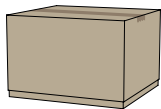

Box 2: Legs + mounting kit

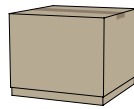

Box dimensions (mm)		L	W	H	Qty	Volume (m ³)	Gross weight (kg)	Net weight (kg)	Packaging weight (kg)
Sliding Chair	Box 1	735	665	490	1	0,24	7,20	4,00	3,20
	Box 2	590	590	470	1	0,16	6,90	3,50	3,40
	Total					0,40	14,10	7,50	6,60
High sliding Chair	Box 1	735	665	490	1	0,24	7,20	4,00	3,20
	Box 2	590	590	750	1	0,26	8,60	5,20	3,40
	Total					0,50	15,80	9,20	6,60

Dimensions

The Pipe Chair is available in one dimension

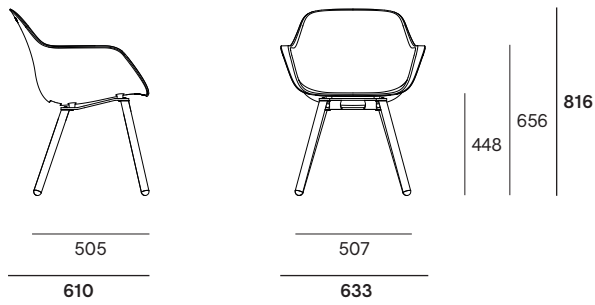

Box dimensions

The Pipe Chair comes in 2 boxes

Max. 6 shells per box: 0,29 m³ | Gross weight: 27,20 kg | Net weight: 24,00 kg

Box 1: Shell

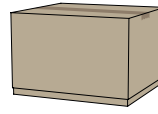

Box 3: Legs + frame + mounting kit



Box dimensions (mm)		L	W	H	Qty	Volume (m ³)	Gross weight (kg)	Net weight (kg)	Packaging weight (kg)
Pipe chair	Box 1	735	665	490	1	0,24	7,20	4,00	3,20
	Box 3	464	318	79	1	0,01	5,80	5,30	0,50
					Total	0,25	13,00	9,30	3,70

Dimensions

The cushion is available in one dimension

The cushions are delivered inside the box of the shells.





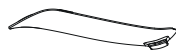



459

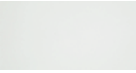





446









Shell

	White (RAL9016) Structured powder coating
	Black (RAL9005) Structured powder coating
	Earth Structured powder coating
	Papyrus white (RAL9018) Structured powder coating
	Verdigris Structured powder coating
	Reed green (RAL6013) Structured powder coating







Sunbrella® cushions

	Grey chiné Sunbrella Natté
	Dark taupe Sunbrella Natté
	Marble Sunbrella Lopi
	Charcoal Sunbrella Lopi
	Leaf green Sunbrella Heritage

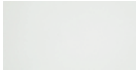



Sliding legs

	Black (RAL9005) Structured powder coating
	Earth Structured powder coating
	Beach beige (RAL1019) Structured powder coating
	Off white (RAL9002) Structured powder coating
	Verdigris Structured powder coating
	Reed green (RAL6013) Structured powder coating
	Copper brown (RAL8004) Structured powder coating
	Galvanized steel

High sliding legs

	White (RAL9016) Structured powder coating
	Black (RAL9005) Structured powder coating
	Earth Structured powder coating
	Papyrus white (RAL9018) Structured powder coating
	Verdigris Structured powder coating
	Reed green (RAL6013) Structured powder coating
	Galvanized steel

Pipe legs

	Black (RAL9005) Structured powder coating
	Earth Structured powder coating
	Beach beige (RAL1019) Structured powder coating
	Off white (RAL9002) Structured powder coating



Materials	Key facts	Thickness	Layer thickness	Density	In/outdoor	Water	UV color fastness	Flame retarding
		mm	micron					
Polypropylene shell	<ul style="list-style-type: none"> Reinforced polypropylene (17% fiberglass) 	5 - 8	n.a.	0,90 10 ³ kg/m ³	Outdoor & indoor	n.a.	Very good UV-resistance	/
Structured powder coated steel legs (sliding & high sliding chair)	<ul style="list-style-type: none"> Easy to clean Cold galvanized, then powder coated 	12	100	7,50 10 ³ kg/m ³	Outdoor & indoor	n.a.	Very good: color can fade to some extent when exposed to UV	NEN-EN13501-1 A1 *
Hot dip galvanized steel (sliding & high sliding chair)	<ul style="list-style-type: none"> Most durable method for protecting metal from rusting Protective layer Very long life span 100% recyclable Cradle to Cradle Certified™ 	2 - 10	50 - 100	7,50 10 ³ kg/m ³	Outdoor & indoor	n.a.	Very good, galvanization will however become less shiny when used outdoors	NEN-EN13501-1 A1 *
Structured powder coated stainless steel legs (pipe chair)	<ul style="list-style-type: none"> Easy to clean Stainless steel (for protection against rust), then powder coated More scratch-resistant than non structured powder coated 		80	8,00 10 ³ kg/m ³	Outdoor & indoor	n.a.	Very good: color can fade to some extent when exposed to UV	NEN-EN13501-1 A1 *
Sunbrella® cushions	<ul style="list-style-type: none"> 100% Sunbrella Acrylic Best outdoor fabric available for making cushions Dirt repellent Not waterproof, store inside! Machine washable at max. 30°C. Ironing restores the protective layer 	0,50	n.a.	260 g/m ²	Outdoor & indoor	The fabric has a water column of 350 mm (EN 20811)	7/8 (ISO 105-B02)	/

NEN-EN13501-1 A1

Class A1 products will not contribute to fire in any stage, including fully developed fire. For this reason, they are assumed to be capable of satisfying all requirements of all lower classes as well.

DIN 4102 - B2/M2

Kleinbrenner: Class B2: All materials used in buildings in Germany need to meet the B2 requirement which is determined using a small flame test.

Good to know

- Because the shells and frames are separately stackable, they don't take up a lot of transport volume.
- No need for extra straps to fix the cushions.
- There is a water drain and ventilation hole in the shell.
- Captain's Chair combines perfectly with:



With Marina combo



With Marina table



With Marina high table



With Panigiri



With Hopper combo



With Pantagruel high table

Maintenance

SHELL

- Use common kitchen cleaning products. Avoid using aggressive products. These surfaces are best cleaned with a neutral cleaning product diluted in water.

POWDER COATED LEGS

- White powder coating obviously requires more maintenance.

GALVANIZED STEEL LEGS

- Clean with lukewarm water and a mild detergent or Extremis multi cleaner.

SUNBRELLA

- Shake or brush off loose dirt immediately.
- Spray Extremis Multi Cleaner.
- Use a soft brush and make circular movements.
- Let the suds soak in for a moment.
- Rinse thoroughly to remove all soap residue.
- Simply allow to dry.
- It's also possible to put the blanket and the pillow covers in a washing machine (max 40°C). Follow the cleaning instruction on the label.
- If the cushion has metal brackets, we recommend turning the cover inside out first to avoid damaging the washing machine. In this case, leave the zipper open about 10 cm.

F.A.Q.

Q: Is the chair weatherproof?

A: Yes, except for the versions with wheels. The shell and frame of the Captain's Chair are made of durable, UV- & water proof materials. The shape of the shell makes sure water can evacuate easily

Warnings

General

- Do not use any sharp tools to open the packaging.
- We strongly advise against using power tools.
- Tripping hazard, mind your step.
- Do not put out cigarettes on the chair.
- Not graffiti proof.
- Do not leave children unattended whilst playing on the chair.
- To avoid danger of suffocation, keep plastic bags away from babies and children.
- Colors can differ over years and from batch to batch.

Product

- Stains should be removed immediately with a clean, soft cloth, particularly in case of dark-colored liquids such as wine, ink, coffee, coke, oil or bird droppings. If left to dry, these liquids may cause permanent damage.
- The chairs are weatherproof, except for the versions with wheels
- Do not stand on the chairs.

- Max. 120 kg per chair
- Do not lean backwards, always stay on 4 feet.
- Store the cushions indoors when not used.
- Risk of suffocation in plastic bags.

Polypropylene

- Avoid using aggressive & abrasive products.
- Very good UV-resistance.

Powder coating

- White powder coating requires more maintenance.
- Do not use abrasive scouring powders or scourers as they will scratch the surface.
- Color can fade to some extent when exposed to UV.
- Flame retarding - NEN-EN13501-1 A2-sl - Satisfying the same criteria as Class B for the SBI-test according to EN13823. In addition, under conditions of a fully developed fire these products will not significantly contribute to the fire load and fire growth.
- Dark colors can get very hot in sunny weather.

Galvanized steel

- Galvanization will become less shiny when used outdoors.
- Flame retarding - NEN-EN13501-1 A1 - Class A1 products will not contribute to fire in any stage, including fully developed fire. For this reason, they are assumed to be capable of satisfying all requirements of all lower classes as well.
- Possible impurities in the immersion tank can cause black marks during galvanization, which are intrinsic to this industrial finishing technique.
- White marks on this zinc layer are also intrinsic to this procedure and will disappear when the furniture is put outdoors.
- This industrial finishing technique may result in a rougher surface. This is intrinsic to the process.

Sunbrella

- Not waterproof, store inside!
- Shake or brush off loose dirt immediately.
- UV color fastness: 7/8 (ISO 105-B02).