

Keglen 400 Floor

Mounting Instruction Version 2

louis
poulsen

Design BIG

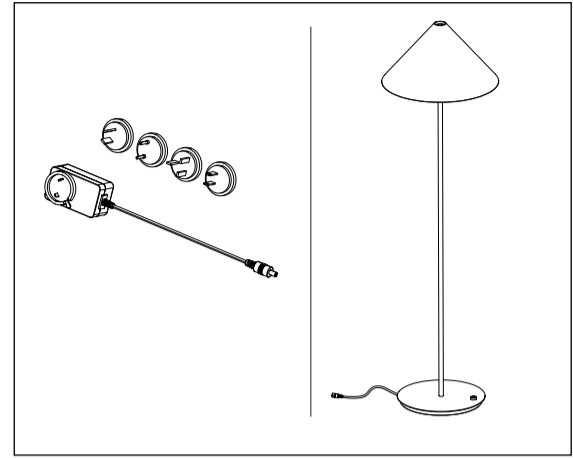
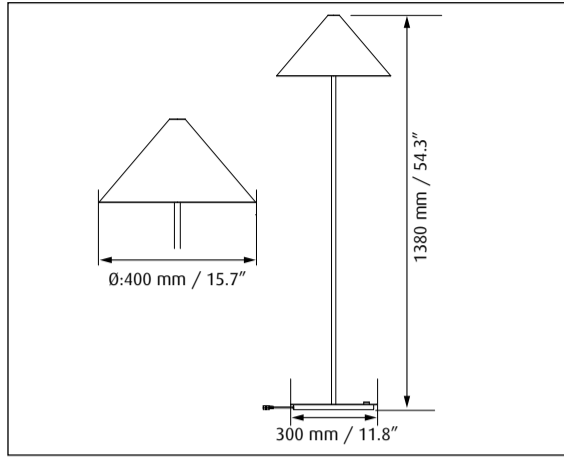
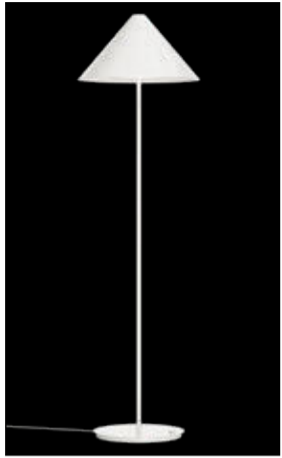

CE
UK
CA
EAC

Lyskilde Light source Leuchtmittel Ljuskälla Sorgenti luminose Source lumineuse Fuente de luz Valonlähde ランプ 광원 光源	Spænding/frekvens Voltage/frequency Spannung/frequenz Spänning/frekvens Tensione/frequenza Voltage/frequence Tensión/frecuencia Jännite/taajuus 電源電圧 / 周波数 전압/주파수 電壓/頻率	Vægt Weight Gewicht Vikt Peso/ingombro Poids Peso Paino 重さ 무게 重量	Isolationsklasse Protection Class Schutzklasse Isolationsklass Classe di isolamento Protection au choc électrique Clase de aislamiento Eristysluokka 感電保護クラス 감전 보호 触电保护	Tæthedsklasse Ingress protection Schutzart Kapslingsklass Grado di protezione Indice de protection Clase de protección Koteloituokka IP클래스 방진방수 入口保护
LED  	AC100-240V, 50/60HZ	7,85kg / 12.31 Lbs	Cl. II	IP20
LED  	DC 12V  SELV	7,85kg / 12.31 Lbs	Cl. III	IP20

DA
Støv aftørres med en tør, blød klud. Fedtpletter og lignende kan fjernes med en blød klud opvredet i lunkent vand (<50° C) tilsat mildt rengøringsmiddel. Brug aldrig rengøringsmidler med slibemiddel eller opløsningsmidler.

EN
Wipe off dust with a dry, soft cloth. Remove greasy spots etc. with a soft cloth dampened in lukewarm water (<50° C) with a mild detergent. Never use detergents containing abrasives and solvents.

DE
Staub bitte mit einem trockenen, weichen Lappen abwischen. Fettflecke und dgl. mit einem feuchten, in lauwarmem Wasser (<50° C) mit mildem Reinigungsmittel ausgewaschenen Lappen entfernen. Niemals Reinigungsmittel mit Schleifmittel oder Lösungsmittel verwenden.

SV
Lampan dammtorkas med en torr, mjuk trasa. Fettfläckar tas bort med ljummet vatten (<50° C) utblandat med mildt rengöringsmedel. Använd aldrig rengöringsmedel som innehåller slipmedel eller lösningsmedel

IT
Pulire la polvere esterna con un panno morbido e asciutto. Rimuovere macchie di grasso ecc. con un panno morbido inumidito in acqua tiepida (<50° C) e con un detergente leggero. Non usare mai detersivi contenenti abrasivi o solventi.

FR
Essuyez la poussière avec un chiffon sec et doux. Enlevez les points de saleté etc. avec un chiffon doux imprégné d'eau claire tiède et de détergent doux. Ne jamais utiliser de détergents contenant des abrasifs et des solvants.

ES
Limpiar con paño seco y suave. Quitar manchas de grasa y otras con paño suave humedecido con agua templada (<50° C) con detergente poco agresivo. Nunca use detergentes que contengan abrasivos y disolventes.

FI
Pyyhi pölyt kuivalla pehmeällä liinalla. Poista rasvatahrat miedolla pesuaineella ja haa-lealla vedellä (<50° C) kostutetulla pehmeällä liinalla. Älä koskaan käytä liuottimia tai hankausaineita sisältäviä pesuaineita.

JP
ホコリは乾いた柔らかい布で拭き取ってください。塗装部分の油汚れ等は、中性洗剤を溶かしたぬるま湯(50°C以下)に柔らかい布を浸し、よくしぼってから拭き取ってください。シンナー・ベンジン等の揮発物や、つや出し剤・研磨剤は使用しないでください。

KR
부드럽고 마른 천으로 먼지를 닦으십시오. 기름 얼룩 등은 중성 세제를 섞은 미지근한 물(50°C 미만)에 적신 부드러운 천으로 닦으십시오. 절대로 연마재와 용매를 포함하고 있는 세제를 사용하지 마십시오.

CN
用于干燥和柔软的布擦去灰尘。用柔布沾温水(低于50度)和温和型的清洁剂除去油腻点。切勿使用含磨料和溶解性的清洁剂。



Replaceability & Energy Efficiency Class

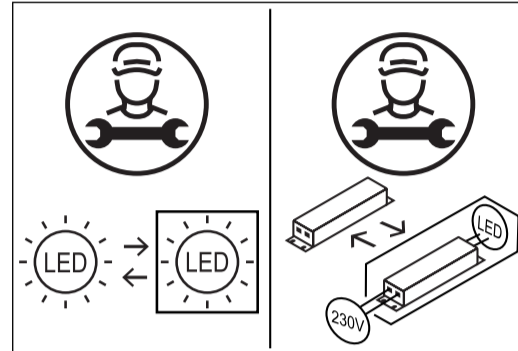

DA
Dette produkt indeholder en lyskilde i energieffektivitetsklasse E

EN
This product contains a light source of energy efficiency class E

DE
Dieses Produkt enthält eine Lichtquelle der Energieeffizienzklasse E

SV
Denna produkt innehåller en ljuskälla med energieffektivitetsklass E

IT
Questo prodotto contiene una sorgente luminosa di classe di efficienza energetica E

FR
Ce produit contient une source lumineuse de classe d'efficacité énergétique E

ES
Este producto contiene una fuente luminosa de la clase de eficiencia energética E

FI
Tämä tuote sisältää valonlähteen, jonka energiatehokkuusluokka on E

JP
この製品には、エネルギー効率クラスEの光源が含まれています

KR
이 제품에는 에너지 효율 등급 E의 광원이 포함되어 있습니다.

CN
本产品包含能效等级 E 的光源

 **DA**
Lyskilden i dette armatur må kun udskiftes af producenten eller en uddannet elektriker.
Hvis den eksterne fleksible ledning eller kablet til dette armatur beskadiges, skal det udskiftes af producenten, dennes servicerepræsentant eller en person med tilsvarende kvalifikationer for at undgå farlige situationer. Forstærket isolation mellem LV forsyning og styrelederne.

 **EN**
The light source contained in this luminaire shall only be replaced by the manufacturer or a qualified electrician.
If the external flexible cable or cord of this luminaire is damaged, it must only be replaced by the manufacturer or his service agent or a similar qualified person in order to avoid hazardous situations.
Reinforced insulation between LV supply and control.

 **DE**
Das in dieser Leuchte enthaltene Leuchtmittel sollte nur vom Hersteller oder von einem qualifizierten Elektriker ausgetauscht werden.
Im Fall einer Beschädigung des externen flexiblen Leuchtenkabels darf der Austausch des Kabels aus Sicherheitsgründen ausschließlich durch den Hersteller oder eine vom Hersteller benannte Servicestelle oder eine Fachkraft mit geeigneter Qualifikation erfolgen.
Verstärkte Isolierung zwischen Niederspannungsversorgung und Regler.

 **SV**
Ljuskällan i denna armatur ska endast bytas ut av tillverkaren eller en kvalificerad elektriker.
Om den externa flexibla ledningen till armaturen skadas ska den endast bytas ut av tillverkaren eller dennes servicerepresentant eller liknande kvalificerad person för att undvika fara.
Förstärkt isolering mellan lågspänningskälla och strömbrytare.

 **IT**
La sorgente contenuta in questa parte illuminante sarà solo riposizionata dal produttore o da un elettricista esperto.
Se il cavo esterno flessibile dell'apparecchio è danneggiato, dovrà essere sostituito esclusivamente dal produttore, dal servizio assistenza o da personale qualificato per evitare qualsiasi pericolo.
Isolamento rinforzato tra alimentazione e controllo LV.

 **FR**
La source lumineuse de ce luminaire ne peut être remplacée que par le fabricant ou un électricien qualifié.
Si le cordon ou le câble flexible externe de ce luminaire est endommagé, il doit être exclusivement remplacé par le fabricant, son représentant ou une personne qualifiée afin d'éviter tout danger.
Isolation renforcée entre l'alimentation basse tension et la commande.

 **ES**
La sustitución de la fuente de luz que contiene esta luminaria debe ser llevada a cabo exclusivamente por el fabricante o un electricista profesional.
Si el cable flexible externo de esta luminaria se dañara, debería ser reemplazado únicamente por el fabricante, o por su agente autorizado, o por una persona cualificada para así evitar peligros.
Aislamiento reforzado entre fuente de baja tensión y control.

 **FI**
Tämän valaisimen valonlähteen saa vaihtaa ainoastaan valmistaja tai koulutettu sähköasentaja.
Vaaratilanteiden välttämiseksi valaisimen vahingoittuneen ulkoisen joustavan kaapelin tai johdon saa vaihtaa vain valmistaja, valtuutettu huoltoliike tai vastaava pätevä taho.
Vahvistettu eristys pienjännitteen syötön ja ohjauksen välillä.

 **JP**
この照明器具のLEDは、一般のランプのように取り換えができません。不点の場合は当社にお問い合わせください。
照明器具は、長時間の凝視が行われるように配置する必要があります
6,74m以上の距離での照明器具は期待できません
この照明器具のLEDは、一般のランプのように取り換えができません。不点の場合は当社にお問い合わせください。
取り外し、取り付けのときは、必ず電源を切って下さい。感電のおそれがあります。

 **KR**
이 등기구에 포함된 광원은 제조업체 또는 자격을 갖춘 전기기사만이 교체할 수 있습니다.
이 조명 기구의 외부 플렉서블 케이블이나 코드가 파손된 경우, 위험을 방지하기 위해 제조업체 또는 제조업체가 지정한 서비스 대리인이나 기타 자격을 갖춘 사람에 의해서만 교체되어야 합니다.
LV 전원과 제어 장치 사이의 절연 보강.

 **CN**
此灯具中的光源只能由制造商或具备相应资格的电工进行更换。
如果此灯具的外部软电缆或软线损坏，应由制造商、其服务代理或类似的具备相应资格的人员进行更换，避免发生危险。
加强低压电源和控制之间的绝缘

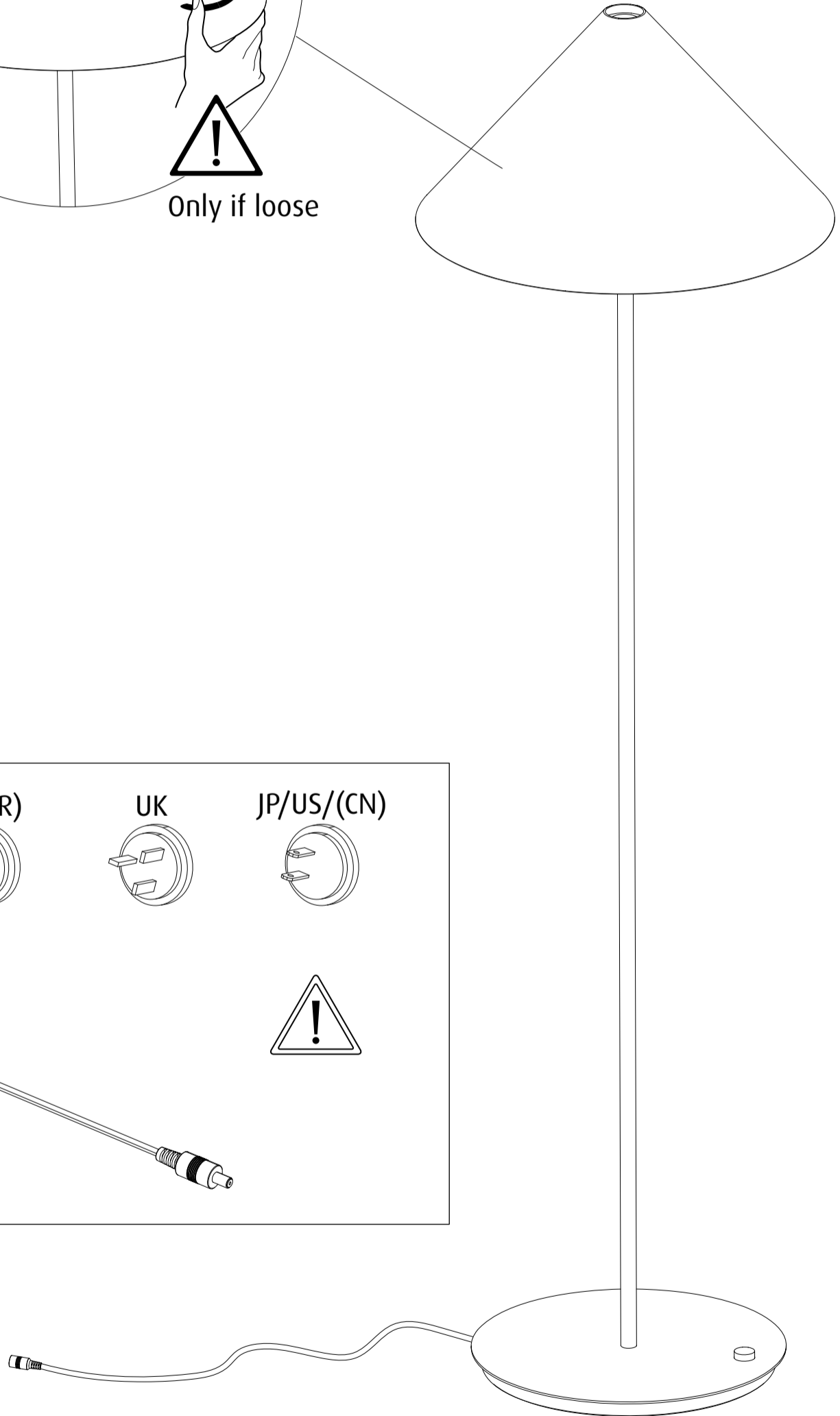
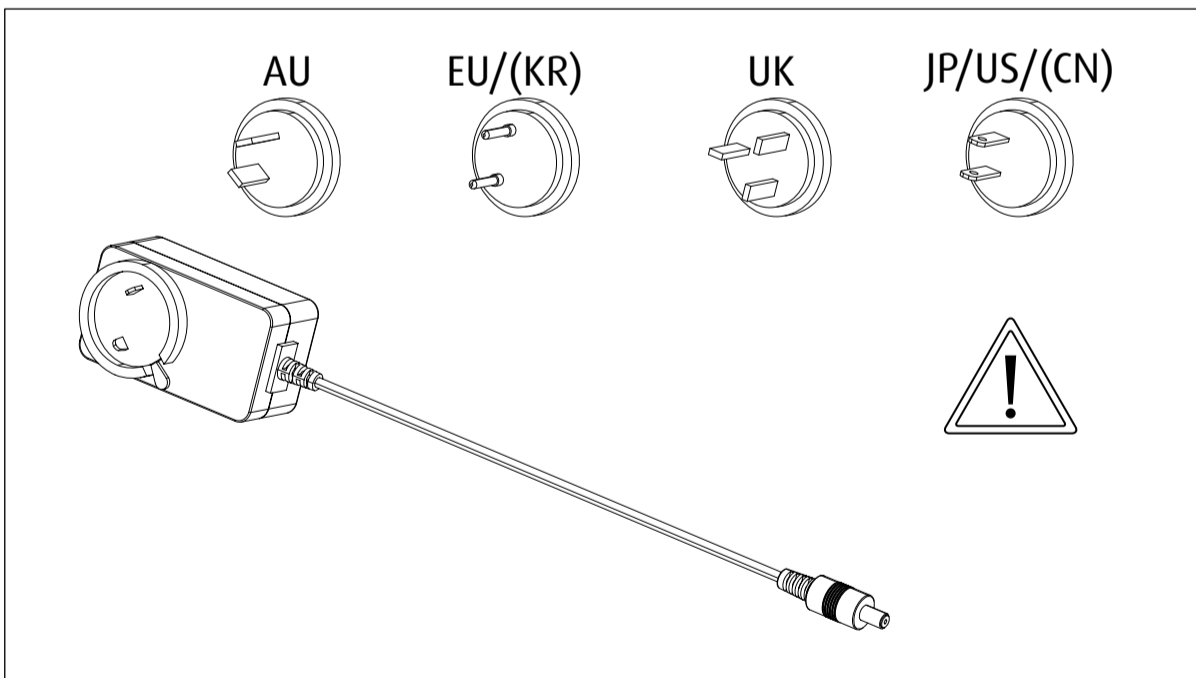
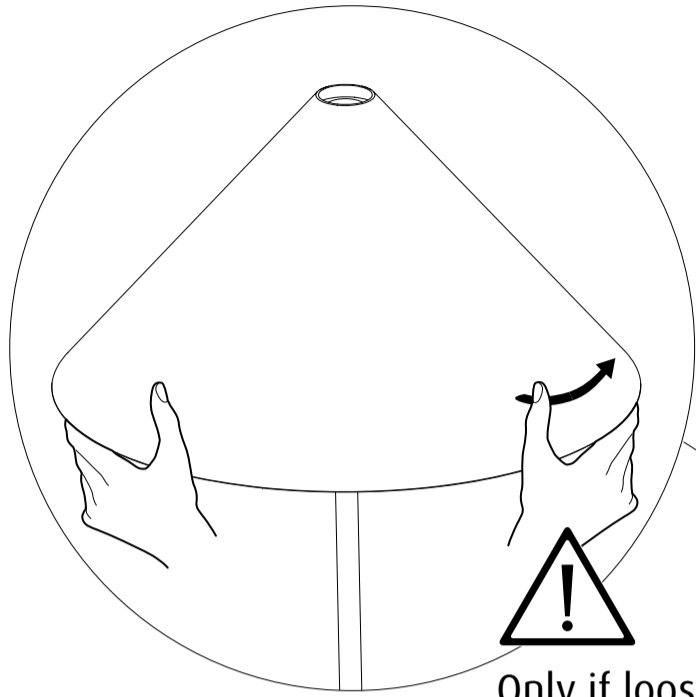
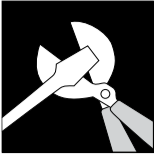

Keglen Floor - Electronic Functions

Mounting Instruction Version 2

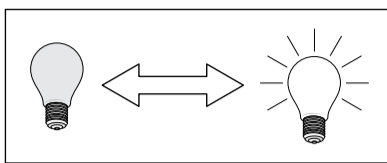

Light on/off:

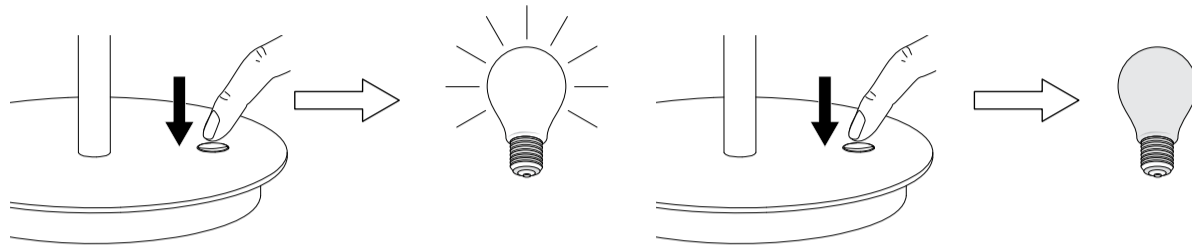

Dimming Function:

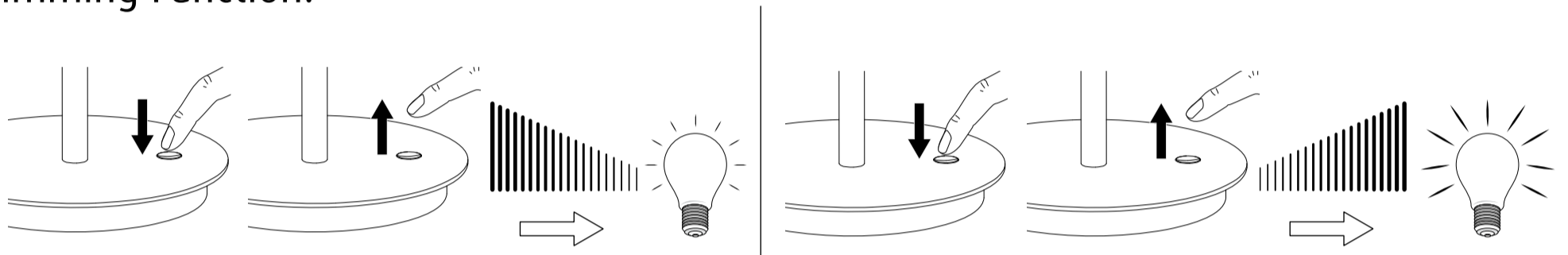

Additional User Settings

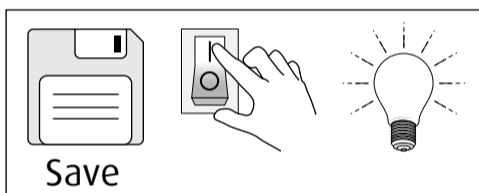

A Lock on/off Button Function

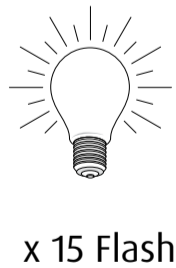
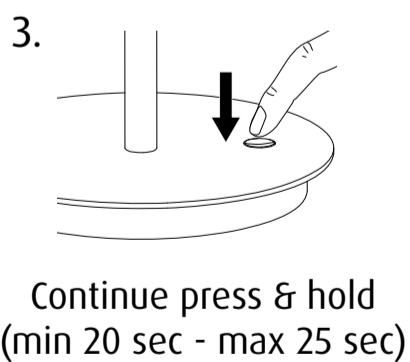
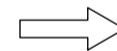
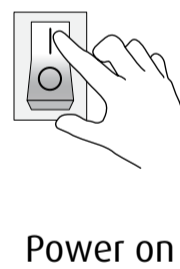
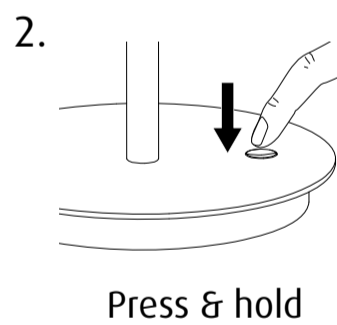
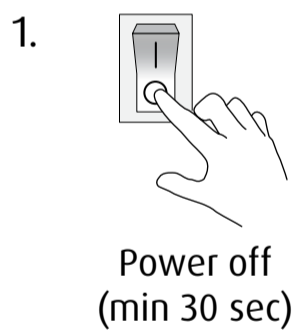

Lock on/off Button Deactivated

Button is locked and cannot be used to turn on/off the light

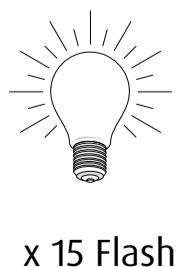
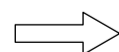
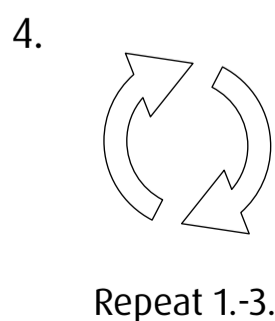

Lock on/off Button Activated

Button is unlocked and can be used to turn on/off the light

Keglen Floor - Electronic Functions

Mounting Instruction Version 2

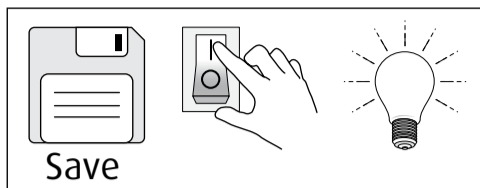

B Set default brightness level (User Function) Factory reset to deactivate brightness level when set

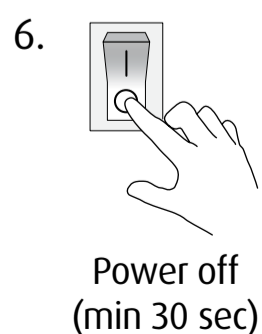
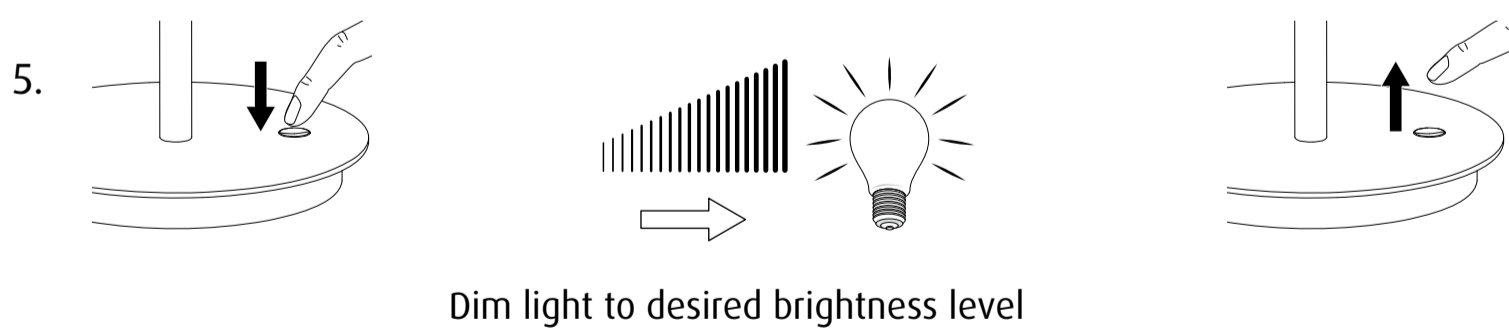
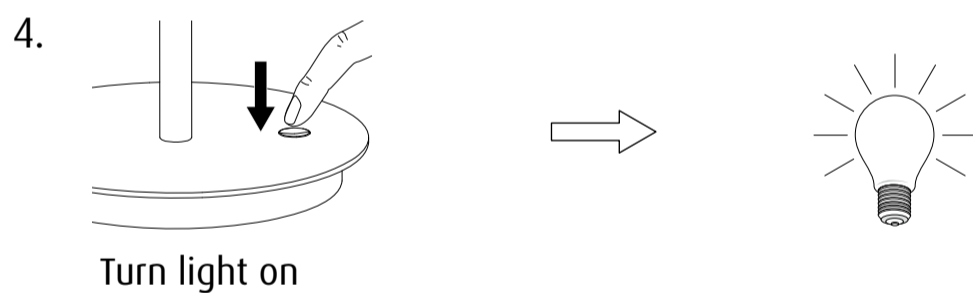
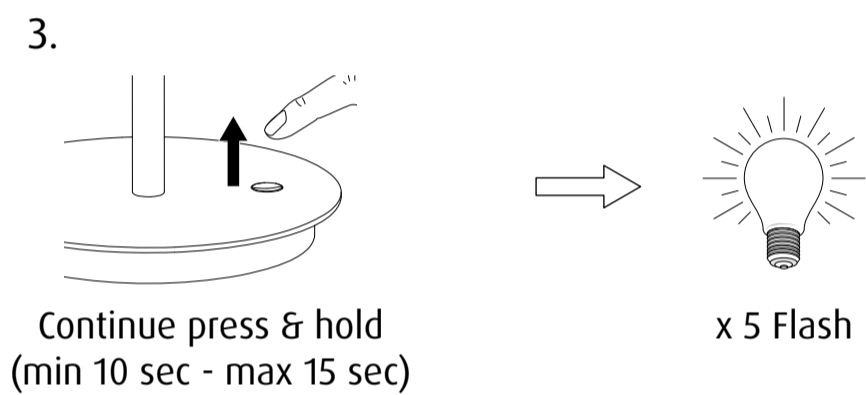
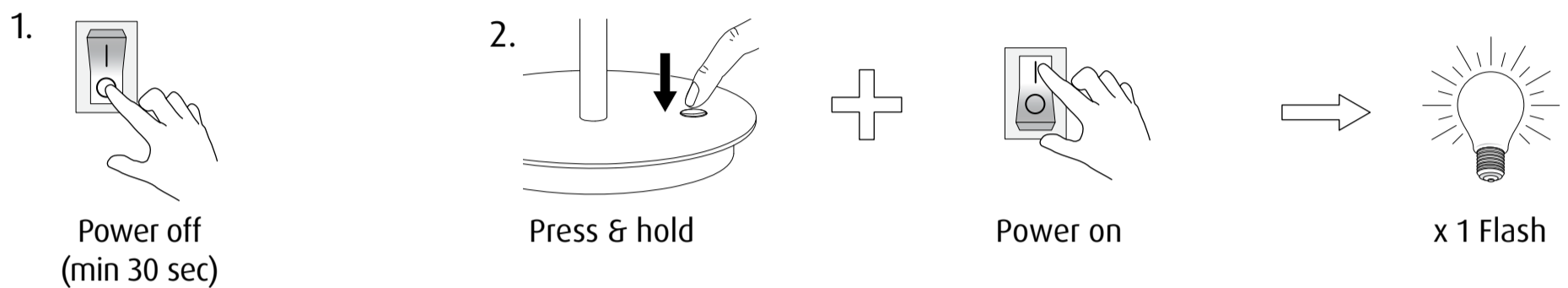

Keglen Floor - Electronic Functions

Mounting Instruction Version 2

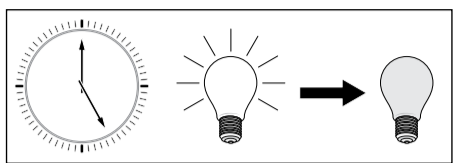

C Timing Function (User Function) Set timer to automatically turn off after period of time

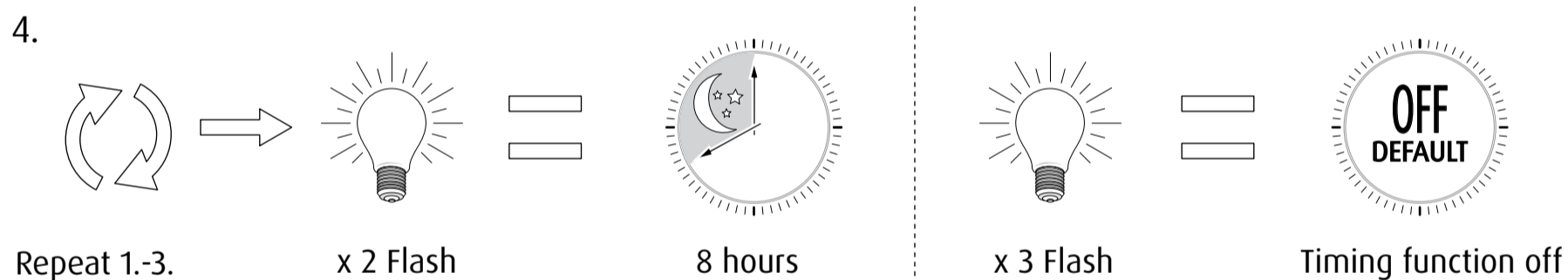
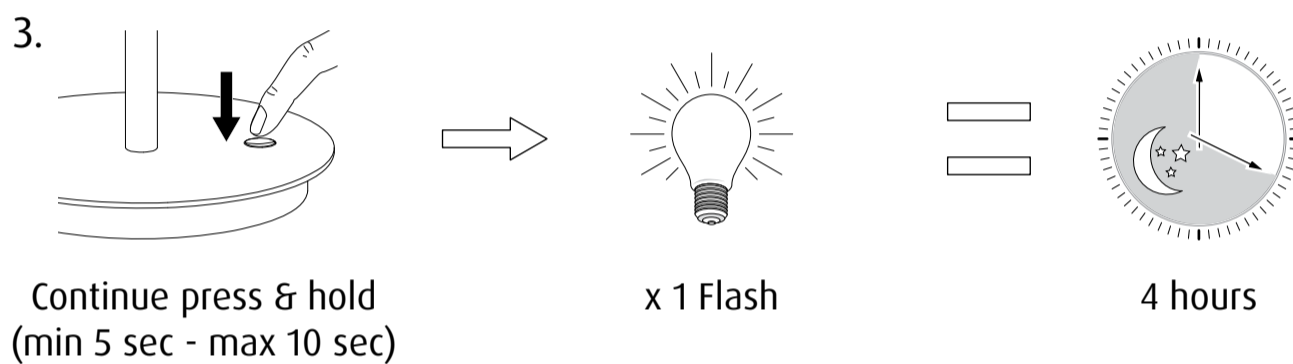
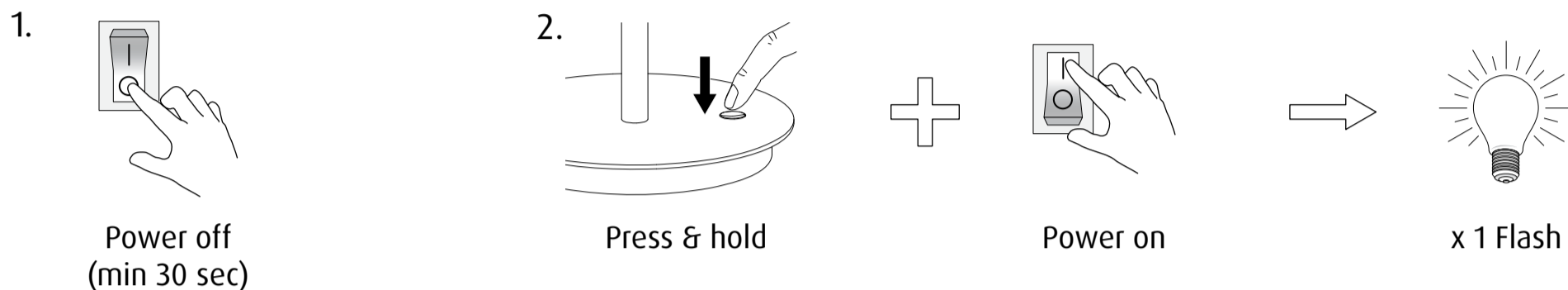

D Dimming Function: Deactivate (User Function) Factory reset to activate dimming function

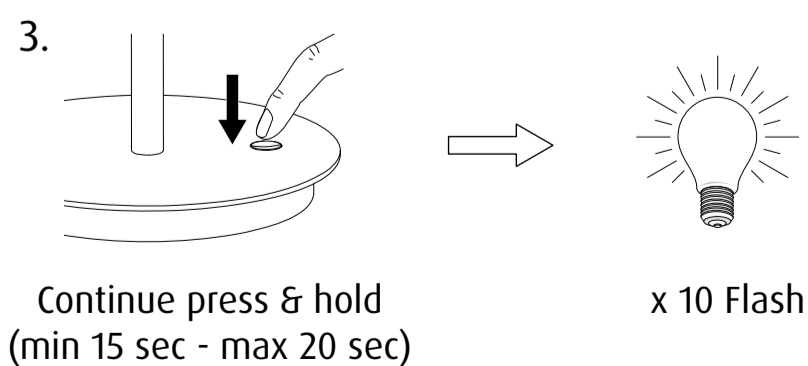
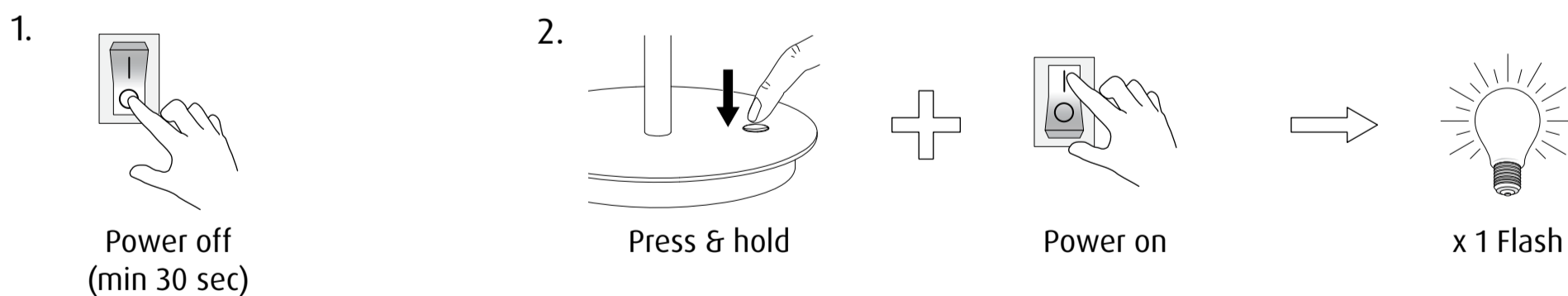

Keglen Floor - Electronic Functions

Mounting Instruction Version 2

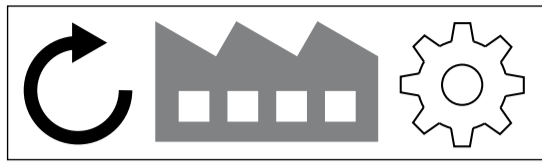

Restore factory default settings:

This is the standard setting for this product.

With this setting the on/off button and dimming function is active.

1.

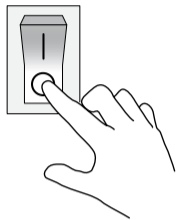

Power off
(min 30 sec)

2.

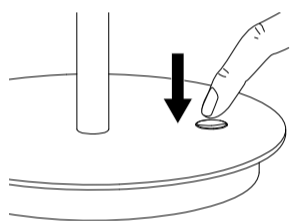

Press & hold

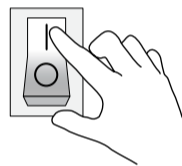

Power on

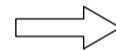

x 1 Flash

3.

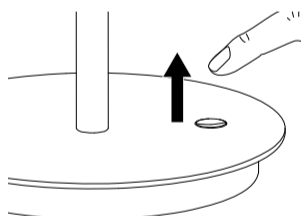

Continue press & hold
(min 25 sec)

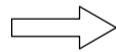

x 20 Flash