



INUMBRINA

© *design by dirk wynants*

READ INSIDE

ASSEMBLY INSTRUCTIONS,
HOW TO USE, USEFUL TIPS
FOR KEEPING YOUR TOOL FOR
TOGETHERNESS IN SHAPE

LANGUAGES

EN – NL – DE – FR – IT – ES

MORE

WWW.EXTREMIS.COM

PRODUCT

INUMBRINA – FLOOR FASTENING – BASE PLATE –
FIXATION INTO ABACHUS – FIXATION INTO ANKER –
MAINTENANCE

LANGUAGES

ENGLISH

contents
assembly directly to the floor
open / close inumbrina
assembly inumbrina base plate
assembly inumbrina into abachus
maintenance

NEDERLANDS

inhoud
montage grondverankering
inumbrina openen / sluiten
montage inumbrina voetplaat
montage inumbrina in abachus
onderhoud

DEUTSCH

inhalt
montage bodenverankerung
inumbrina öffnen / schließen
montage inumbrina mit bodenplatte
montage inumbrina im abachus
pflege

P. 3

p. 3
p. 4
p. 4
p. 5
p. 5
p. 7

P. 9

p. 9
p. 10
p. 10
p. 11
p. 11
p. 13

P. 15

p. 15
p. 16
p. 16
p. 17
p. 17
p. 19

FRANÇAIS

contenu
montage fixation dans au sol
ouvrier / fermer inumbrina
montage inumbrina pied circulaire
montage inumbrina dans abachus
entretien

ITALIANO

contenuto
montaggio diretto al suolo
apertura / chiusura inumbrina
montaggio inumbrina piastra di base
montaggio inumbrina con abachus
manutenzione

ESPAÑOL

contenido
montaje fijación directamente sobre el suelo
abierto / cerca inumbrina
montaje inumbrina placa de apoyo
montaje inumbrina en la mesa abachus
mantenimiento

P. 21

p. 21
p. 22
p. 22
p. 23
p. 23
p. 25

P. 27

p. 27
p. 28
p. 28
p. 29
p. 29
p. 31

P. 33

p. 33
p. 34
p. 34
p. 35
p. 35
p. 37

CONTENTS

INUMBRINA WITH ASSEMBLY DIRECTLY TO THE FLOOR



1 x inumbrina

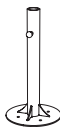

1 x extension tube

INUMBRINA ON BASE PLATE



1 x inumbrina

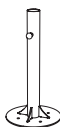

1 x extension tube



1 x base plate

INUMBRINA INTO ABACHUS



1 x inumbrina

ASSEMBLY INUMBRINA DIRECTLY TO THE FLOOR

WHAT YOU NEED



1 person



+/- 30 min.

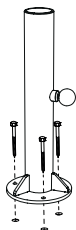

1. Position the stainless steel anchor tube where you want to install the parasol. Fix it tightly to the ground using anchor bolts (or other fixing mediums adapted to the surface in question).
2. Insert the Inumbrina parasol in the anchor tube and fasten it by turning the adjusting screw clockwise. Always tighten the adjusting screw until the Inumbrina can no longer revolve on its axle.

USE

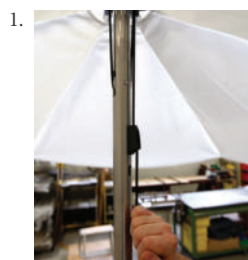

1. To open the parasol, firmly pull the rope until the parasol fabric is almost completely horizontal.

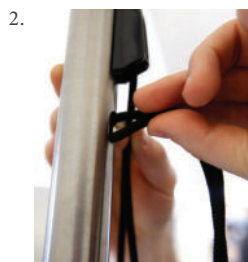

2. To put the rope in the tube, you should fold it in 2 and put the loop in the hole until it is completely tucked away.



To close the parasol again, take the rope out of the tube and hold it in a slight angle. **TIP:** keep the rope aslope until the parasol is completely closed.

ASSEMBLY INUMBRINA ON BASE PLATE

WHAT YOU NEED



1 person



no. 4 hex key



+/- 20 min.

Standard parasol base

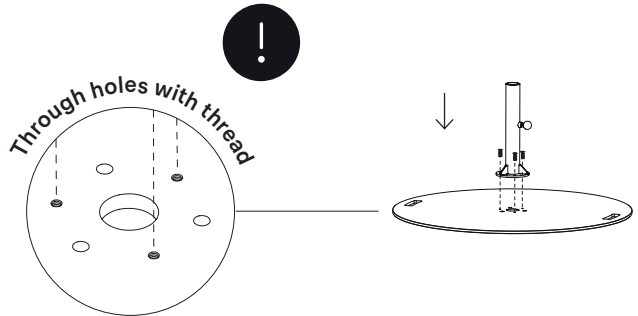

1. Place the galvanised steel base plate on the ground and mount the stainless steel tube on it with 3 bolts M6x12. Attention: Make sure that you fix the bolts in the thread of the base plate as shown on the drawing.

2. Insert the Inumbrina parasol in the anchor tube and fasten it by turning the adjusting screw clockwise. Always tighten the adjusting screw until the InUmbrina can no longer revolve on its axle.

Heavy duty parasol base

1. Place one of the two galvanised base plates on the ground. Then position the second base plate on top of it, make sure the square holes match the round holes with thread of the first base plate. Now place the stainless steel tube on top of the two base plates and make sure the holes of the tube match with the square holes of the second base plate. Mount the stainless steel tube on it with 3 bolts M6x20. Attention: Make sure that you fix the bolts in the thread of the first base plate as shown on the drawing!
2. Plaats vervolgens de Inumbrina parasol in de basis, en vergrendel door de stelschroef in wijzerzin te draaien. Pas als de Inumbrina niet meer rond haar as kan bewegen, is de stelschroef voldoende vastgeklemd.

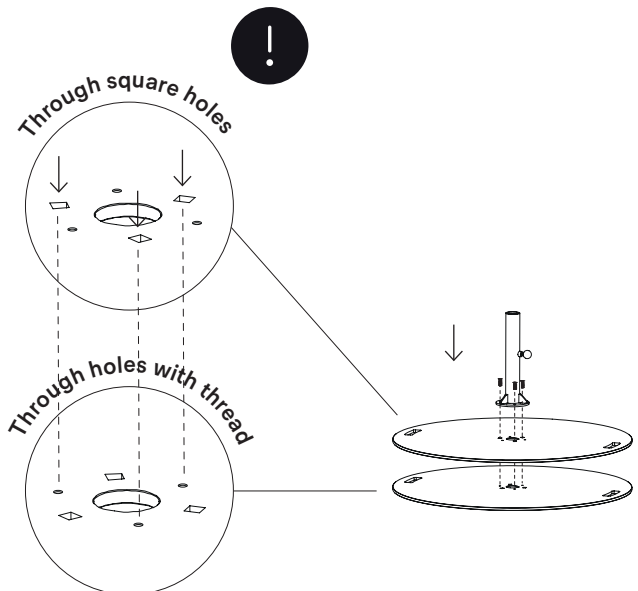

ASSEMBLY INUMBRINA INTO ABACHUS

WHAT YOU NEED



1 person



+/- 5 min.

Insert the Inumbrina parasol in the Abachus anchor tube and fasten it by turning the adjusting screw clockwise. Always tighten the adjusting screw until the Inumbrina can no longer revolve on its axle.

ATTENTION: It is only possible to combine Inumbrina 25 with the Abachus.

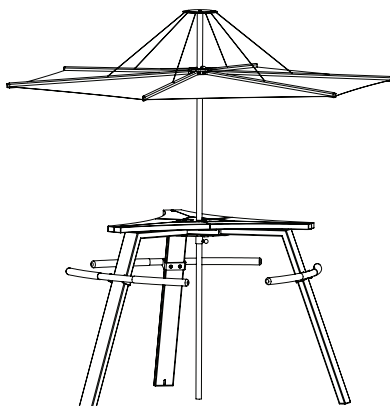

ASSEMBLY INUMBRINA IN ANKER

WHAT YOU NEED



1 person



+/- 5 min.

To create shade with the Anker, we recommend the Inumbrina 32.

1. Remove the cover disc.
2. Insert the Inumbrina parasol into the Anker and lock it into place by turning the knob clockwise. The knob is only sufficiently tightened when the Inumbrina can no longer rotate on its axis.

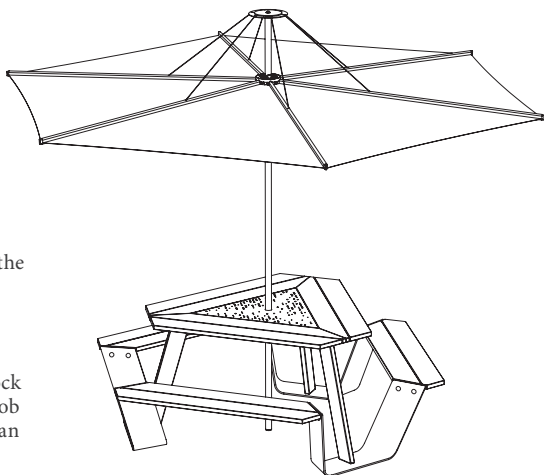

MAINTENANCE

FABRIC

Clean the fabric of the parasol and the slip over cover by rinsing it with water and hand soap, cleaning it with a soft brush. First and foremost beware that the parasol does not get dirty and use the slip over cover as much as possible.

We strongly advise you not to use a high-pressure hose.

Do not use any aggressive detergents, as they will remove the protective coating of the fabric.

STAINLESS STEEL TUBE

Stainless steel is not sea water proof. Especially in an aggressive environment (maritime climate, chlorine, acid rain, aggressive industrial or urban environment) we recommend to frequently use surface cleansing, the adequate products necessary therefore are generally available.

WARNING

In case of strong winds or when not in use, protect the Inumbrina with the (optional) parasol cover or store it indoors to avoid the parasol from blowing open or getting dirty.

Do not leave the parasol unattended when opened.

For ventilation purposes, the cover is not 100% water proof.

Do not leave closed if not completely dry. Do not leave the parasol closed for a long time if it is still damp or wet.

Store the parasol when not in use for a long time as follows: vertically, completely dry and in a dry environment.

LANGUAGES

ENGLISH

contents
assembly directly to the floor
open / close inumbrina
assembly inumbrina base plate
assembly inumbrina into abachus
maintenance

NEDERLANDS

inhoud
montage grondverankering
inumbrina openen / sluiten
montage inumbrina voetplaat
montage inumbrina in abachus
onderhoud

DEUTSCH

inhalt
montage bodenverankerung
inumbrina öffnen / schließen
montage inumbrina mit bodenplatte
montage inumbrina im abachus
pflege

P. 3

p. 3
p. 4
p. 4
p. 5
p. 5
p. 7

P. 9

p. 9
p. 10
p. 10
p. 11
p. 11
p. 13

P. 15

p. 15
p. 16
p. 16
p. 17
p. 17
p. 19

FRANÇAIS

contenu
montage fixation dans au sol
ouvrier / fermer inumbrina
montage inumbrina pied circulaire
montage inumbrina dans abachus
entretien

ITALIANO

contenuto
montaggio diretto al suolo
apertura / chiusura inumbrina
montaggio inumbrina piastra di base
montaggio inumbrina con abachus
manutenzione

ESPAÑOL

contenido
montaje fijación directamente sobre el suelo
abierto / cerca inumbrina
montaje inumbrina placa de apoyo
montaje inumbrina en la mesa abachus
mantenimiento

P. 21

p. 21
p. 22
p. 22
p. 23
p. 23
p. 25

P. 27

p. 27
p. 28
p. 28
p. 29
p. 29
p. 31

P. 33

p. 33
p. 34
p. 34
p. 35
p. 35
p. 37

INHOUD

INUMBRINA MET GRONDVERANKERING



1 x inumbrina

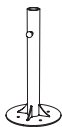

1 x verlengpaal grondverankering

INUMBRINA OP VOETPLAAT



1 x inumbrina

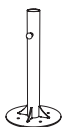

1 x verlengpaal grondverankering



1 x voetplaat

INUMBRINA IN ABACHUS



1 x inumbrina

MONTAGE INUMBRINA MET GRONDVERANKERING

BENODIGDHEDEN



1 persoon



+/- 30 min.

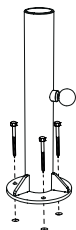

1. Plaats de rvs onderbuis op de plaats waar u de parasol wil opstellen en maak deze stevig vast aan de ondergrond d.m.v. ankerbouten (of de bevestigingsmiddelen die best geschikt zijn voor uw ondergrond).
2. Plaats vervolgens de Inumbrina parasol in de basis, en vergendel door de stelschroef in wijzerzin te draaien. Pas als de Inumbrina niet meer rond haar as kan bewegen, is de stelschroef voldoende vastgeklemd.

GEBRUIK

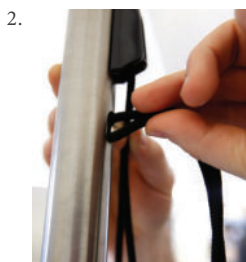
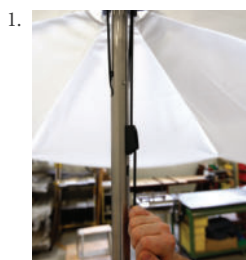

1. Om de parasol te openen, trek je stevig aan het touw, totdat de krans tegen het boutje komt.
2. Om het touw in de buis te stoppen, vouwt men deze in 2 en stopt men de lus in het gaatje tot deze volledig weg zit.



Om de parasol terug te sluiten haal je het touw uit de buis en hou je deze wat schuin. **TIP:** blijf het touw schuin vasthouden tot de parasol volledig gesloten is.

MONTAGE INUMBRINA OP VOETPLAAT

BENODIGDHEDEN



1 persoon



inbussleutel nr. 4



+/- 20 min.

Standaard parasolvoet

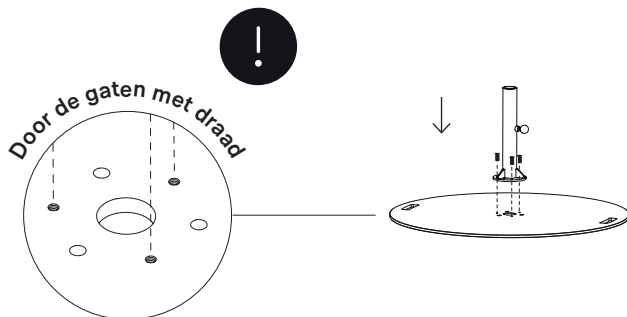

1. Plaats de gegalvaniseerde grondplaat op de grond en monteer de roestvrij stalen buis erop met 3 bouten M6x12. Let op: Zorg ervoor dat je de bouten in de schroefdraad van de grondplaat bevestigt zoals op de tekening!

2. Plaats vervolgens de Inumbrina parasol in de basis, en vergrendel door de stelschroef in wijzerzin te draaien. Pas als de Inumbrina niet meer rond haar as kan bewegen, is de stelschroef voldoende vastgeklemd.

Heavy duty parasolvoet

1. Plaats een van de twee gegalvaniseerde grondplaten op de grond. Vervolgens plaats je de tweede plaat erbovenop, zorg ervoor dat de vierkante gaten van de bovenste plaat overeenkomen met de ronde gaten met schroefdraad van de onderste plaat. Plaats de roestvrij stalen buis op de bovenste plaat. Zorg ervoor dat de gaten van de buis overeenkomen met de vierkante gaten van de bovenste plaat. Monteer deze nu erop met 3 bouten M6x20. Let op: Zorg ervoor dat je de bouten in de schroefdraad van de onderste plaat bevestigt zoals op de tekening!

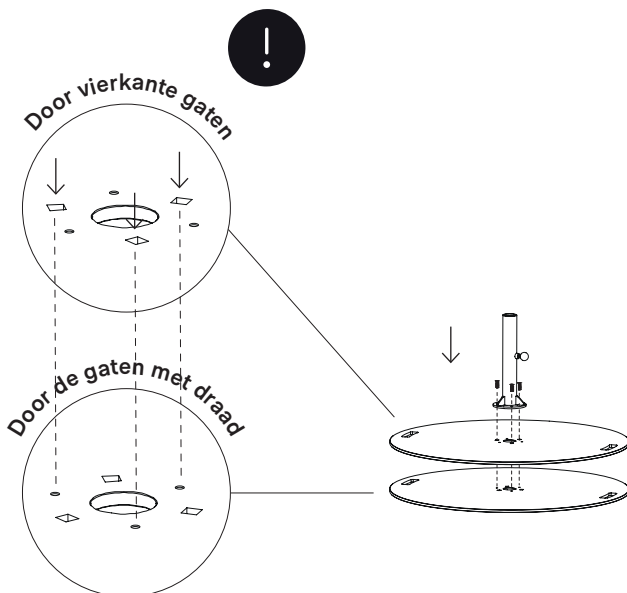

2. Plaats vervolgens de Inumbrina parasol in de basis, en vergrendel door de stelschroef in wijzerzin te draaien. Pas als de Inumbrina niet meer rond haar as kan bewegen, is de stelschroef voldoende vastgeklemd.

MONTAGE INUMBRINA IN ABACHUS

BENODIGDHEDEN



1 persoon



+/- 5 min.

Plaats de Inumbrina parasol in de Abachus, en vergrendel door de draaiknop in wijzerzin te draaien. Pas als de Inumbrina niet meer rond haar as kan bewegen, is de draaiknop voldoende vastgeklemd.

LET OP: Het is enkel mogelijk Inumbrina 25 te combineren met de Abachus.

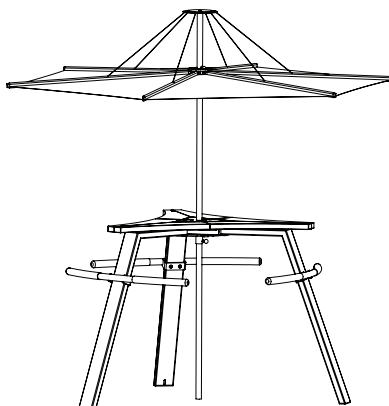

MONTAGE INUMBRINA IN ANKER

BENODIGDHEDEN



1 persoon



+/- 5 min.

Als schaduwmaker raden we bij Anker de Inumbrina 32 aan.

1. Verwijder het afdekschijfje.
2. Plaats de Inumbrina parasol in de Anker, en vergrendel door de draaiknop in wijzerzin te draaien. Pas als de Inumbrina niet meer rond haar as kan bewegen, is de draaiknop voldoende vastgeklemd.

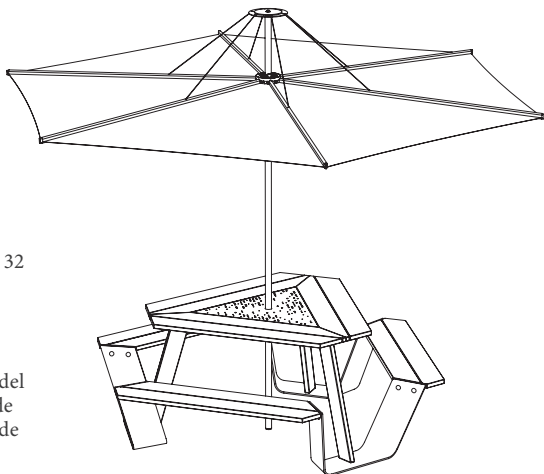

ONDERHOUD

PARASOL STOF

Reinig het zeil van de parasol en de hoes door te spoelen met water en handzeep, en voorzichtig te wrijven met een zachte borstel. Zorg er in eerste instantie voor dat de parasol stof niet te vuil wordt en plaats zo veel mogelijk de hoes over de parasol.

Spuit de parasol nooit af met een hoge drukreiniger.

Gebruik geen detergents. Deze tasten de beschermlaag van het textiel aan.

ROESTVAST STAAL

Roestvast staal is niet zeewaterbestendig. Vooral in een agressieve omgeving (maritiem klimaat, chloor, zure regen, agressieve industriële of stedelijke omgeving) raden wij aan om regelmatig het oppervlak te reinigen. De geschikte producten voor het reinigen van roestvrij staal zijn in de handel te koop.

WAARSCHUWING

Bij niet-gebruik of hevige wind, breng de hoes (optioneel)aan of haal de Inumbrina binnenshuis om te vermijden dat de parasol open waait of vuil wordt.

Laat de geopende parasol nooit onbewaakt achter.

Om ventilatie redenen is de hoes niet 100% waterdicht.

Laat Inumbrina niet gesloten als ze niet volledig droog is. Laat ze niet gedurende lange tijd gesloten in vochtige omstandigheden.

Als u de parasol voor lange tijd niet gebruikt, berg ze dan op als volgt: vertikaal, perfect gedroogd in een droge omgeving.

LANGUAGES

ENGLISH

contents
assembly directly to the floor
open / close inumbrina
assembly inumbrina base plate
assembly inumbrina into abachus
maintenance

NEDERLANDS

inhoud
montage grondverankering
inumbrina openen / sluiten
montage inumbrina voetplaat
montage inumbrina in abachus
onderhoud

DEUTSCH

inhalt
montage bodenverankerung
inumbrina öffnen / schließen
montage inumbrina mit bodenplatte
montage inumbrina im abachus
pflege

P. 3

p. 3
p. 4
p. 4
p. 5
p. 5
p. 7

P. 9

p. 9
p. 10
p. 10
p. 11
p. 11
p. 13

P. 15

p. 15
p. 16
p. 16
p. 17
p. 17
p. 19

FRANÇAIS

contenu
montage fixation dans au sol
ouvrier / fermer inumbrina
montage inumbrina pied circulaire
montage inumbrina dans abachus
entretien

ITALIANO

contenuto
montaggio diretto al suolo
apertura / chiusura inumbrina
montaggio inumbrina piastra di base
montaggio inumbrina con abachus
manutenzione

ESPAÑOL

contenido
montaje fijación directamente sobre el suelo
abierto / cerca inumbrina
montaje inumbrina placa de apoyo
montaje inumbrina en la mesa abachus
mantenimiento

P. 21

p. 21
p. 22
p. 22
p. 23
p. 23
p. 25

P. 27

p. 27
p. 28
p. 28
p. 29
p. 29
p. 31

P. 33

p. 33
p. 34
p. 34
p. 35
p. 35
p. 37

INHALT

INUMBRINA MIT BODENVERANKERUNG



1 x inumbrina und rohr

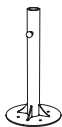

1 x ausdehnung verankerung

INUMBRINA OP VOETPLAAT



1 x inumbrina und rohr

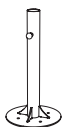

1 x ausdehnung verankerung



1 x bodenplatte

INUMBRINA IM ABACHUS



1 x inumbrina und rohr

MONTAGE INUMBRINA MIT BODENVERANKERUNG

WAS SIE BRAUCHEN



1 Person



+/- 30 min.

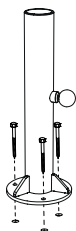

1. Setzen Sie die Edelstahlbodenhülse an der Stelle ein, wo Sie den Sonnenschirm aufstellen wollen. Befestigen Sie sie mit Verankerungsschrauben (oder den Befestigungsmitteln, die für Ihren Boden am besten geeignet sind) im Boden.
2. Stecken Sie danach den Inumbrina in die Basis. Zum Verriegeln drehen Sie die Stellschraube im Uhrzeigersinn. Erst wenn der Inumbrina sich nicht mehr um seine Achse drehen kann, ist die Stellschraube ausreichend angezogen.

GEBRAUCH

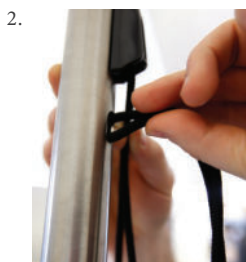
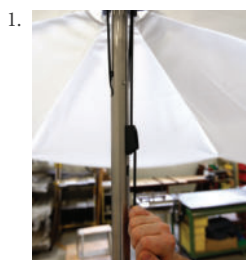

1. Zum Öffnen des Sonnenschirms ziehen Sie kräftig am Seil, bis die Schirmfläche beinahe vollkommen waagrecht ist.
2. Um das Seil in das Rohr zu verstecken, falten Sie das Seil in 2 und stecken Sie die Schleife in das Loch bis es ganz verschwunden ist.



Wenn Sie den Sonnenschirm schließen wünschen, nehmen Sie das Seil aus dem Rohr und neigen Sie es ein bisschen. **HINWEIS:** neigen Sie das Seil bis den Sonnenschirm ganz geschlossen ist.

MONTAGE INUMBRINA AUF BODENPLATTE

WAS SIE BRAUCHEN



1 Person



inbusschlüssel Nr. 4



+/- 20 min.

Standard Sonnenschirmständer

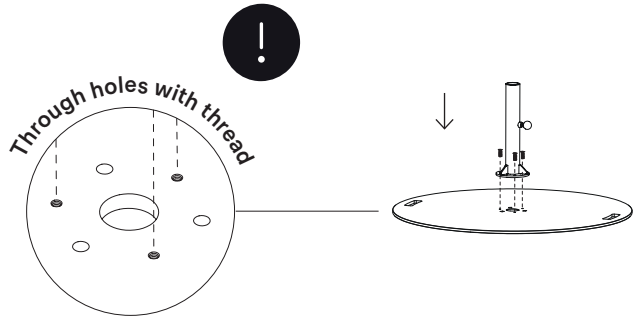

1. Place the galvanised steel base plate on the ground and mount the stainless steel tube on it with 3 bolts M6x12. Attention: Make sure that you fix the bolts in the thread of the base plate as shown on the drawing.

2. Insert the Inumbrina parasol in the anchor tube and fasten it by turning the adjusting screw clockwise. Always tighten the adjusting screw until the InUmbrina can no longer revolve on its axle.

Heavy duty Sonnenschirmständer

1. Place one of the two galvanised base plates on the ground. Then position the second base plate on top of it, make sure the square holes match the round holes with thread of the first base plate. Now place the stainless steel tube on top of the two base plates and make sure the holes of the tube match with the square holes of the second base plate. Mount the stainless steel tube on it with 3 bolts M6x20. Attention: Make sure that you fix the bolts in the thread of the first base plate as shown on the drawing!
2. Plaats vervolgens de Inumbrina parasol in de basis, en vergrendel door de stelschroef in wijzerzin te draaien. Pas als de Inumbrina niet meer rond haar as kan bewegen, is de stelschroef voldoende vastgeklemd.

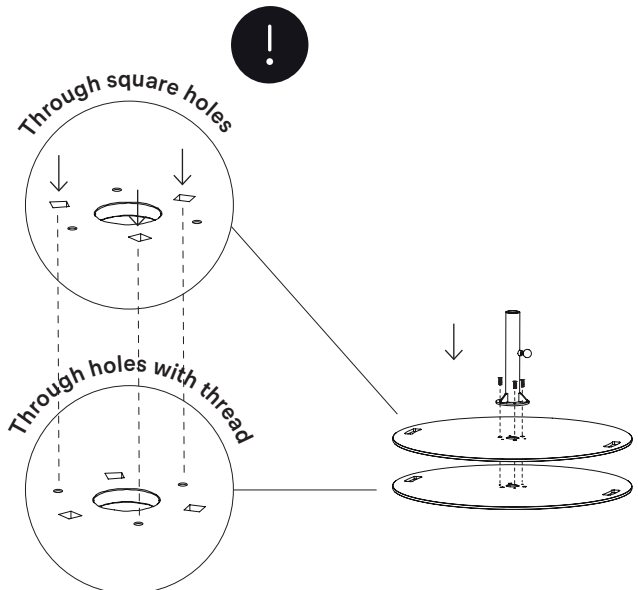

MONTAGE INUMBRINA IM ABACHUS

WAS SIE BRAUCHEN



1 Person



+/- 5 min.

Stecken Sie den Inumbrina in die Basis. Zum Verriegeln drehen Sie die Stellschraube im Uhrzeigersinn. Erst wenn der Inumbrina sich nicht mehr um seine Achse drehen kann, ist die Stellschraube ausreichend angezogen vastgeklemd..

AUFMERKSAMKEIT: Es ist nur möglich Inumbrina 25 zu kombinieren mit der Abachus.

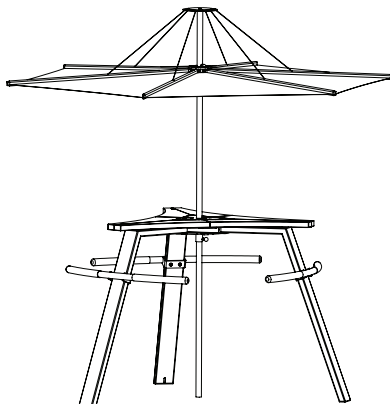

MONTAGE INUMBRINA IM ANKER

BENODIGDHEDEN



1 Person



+/- 5 min.

Als Schattenspender für Anker raten wir zu Inumbrina 32.

1. Entfernen Sie die Abdeckscheibe.
2. Stecken den Inumbrina-Sonnenschirm in den Anker. Zum Verriegeln drehen Sie den Drehknopf im Uhrzeigersinn. Erst wenn sich der Inumbrina nicht mehr um seine Achse bewegen kann, ist der Drehknopf ausreichend angezogen.

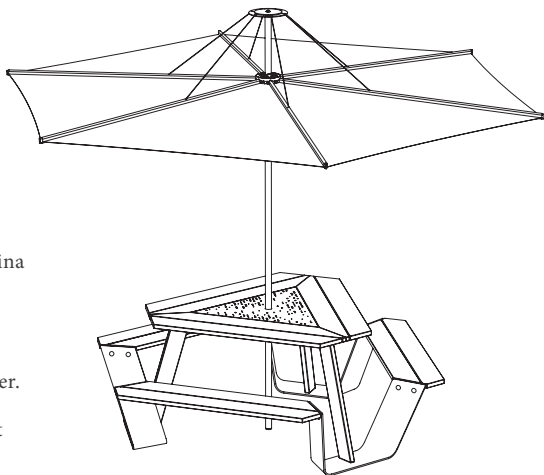

PFLEGE

STOFF

Reinigen Sie den Stoff des Sonnenschirms und den Bezug, indem Sie diese mit Wasser und Seife abspülen und vorsichtig mit einer weichen Bürste abreiben. Achten Sie darauf, dass der Sonnenschirmstoff nicht zu schmutzig wird, und ziehen Sie so oft wie möglich den Bezug über den Sonnenschirm.

Spritzen Sie den Sonnenschirm nie mit einem Hochdruckreiniger ab.

Verwenden Sie keine Reinigungsmittel. Diese greifen die Schutzschicht des Stoffs an

EDELSTAHL ROHR

Edelstahl ist nicht beständig gegen Meerwasser. Insbesondere in einer aggressiven Umgebung (Meeresklima, Chlor, saurer Regen, aggressives industrielles oder städtisches Umfeld) raten wir dazu, die Oberfläche häufig zu reinigen. Geeignete Reinigungsprodukte für

Edelstahl finden Sie im Handel.

WARNUNG

Bei Nichtgebrauch oder starkem Wind ziehen Sie die Hülle (Option) darüber oder holen Sie den Inumbrina ins Haus, um zu vermeiden, dass er sich öffnet oder verschmutzt.

Lassen Sie den geöffneten Sonnenschirm nie unbeaufsichtigt.

Aus Gründen der Belüftung ist die Hülle nicht 100% wasserdicht.

Lassen Sie Inumbrina nicht geschlossen, wenn er nicht vollkommen trocken ist. Lassen Sie ihn bei feuchten Bedingungen nicht für eine längere Zeit geschlossen.

Wenn Sie den Sonnenschirm eine längere Zeit nicht verwenden, bewahren Sie ihn senkrecht und vollkommen getrocknet in einer trockenen Umgebung auf.

LANGUAGES

ENGLISH

contents
assembly directly to the floor
open / close inumbrina
assembly inumbrina base plate
assembly inumbrina into abachus
maintenance

NEDERLANDS

inhoud
montage grondverankering
inumbrina openen / sluiten
montage inumbrina voetplaat
montage inumbrina in abachus
onderhoud

DEUTSCH

inhalt
montage bodenverankerung
inumbrina öffnen / schließen
montage inumbrina mit bodenplatte
montage inumbrina im abachus
pflege

P. 3

p. 3
p. 4
p. 4
p. 5
p. 5
p. 7

P. 9

p. 9
p. 10
p. 10
p. 11
p. 11
p. 13

P. 15

p. 15
p. 16
p. 16
p. 17
p. 17
p. 19

FRANÇAIS

contenu
montage fixation dans au sol
ouvrier / fermer inumbrina
montage inumbrina pied circulaire
montage inumbrina dans abachus
entretien

ITALIANO

contenuto
montaggio diretto al suolo
apertura / chiusura inumbrina
montaggio inumbrina piastra di base
montaggio inumbrina con abachus
manutenzione

ESPAÑOL

contenido
montaje fijación directamente sobre el suelo
abierto / cerca inumbrina
montaje inumbrina placa de apoyo
montaje inumbrina en la mesa abachus
mantenimiento

P. 21

p. 21
p. 22
p. 22
p. 23
p. 23
p. 25

P. 27

p. 27
p. 28
p. 28
p. 29
p. 29
p. 31

P. 33

p. 33
p. 34
p. 34
p. 35
p. 35
p. 37

CONTENU

INUMBRINA AVEC FIXATION DIRECT AU SOL



1 x inumbrina et tube

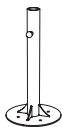

1 x tube de rallonge

INUMBRINA SUR PIED CIRCULAIRE



1 x inumbrina et tube

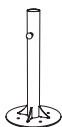

1 x tube de rallonge



1 x pied circulaire

INUMBRINA DANS ABACHUS



1 x inumbrina et tube

MONTAGE INUMBRINA FIXATION DIRECT AU SOL

OUTILS



1 personne



+/- 30 min.

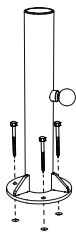

1. Placez le tube inférieur en inox à l'endroit où vous souhaitez installer le parasol, et fixez-le solidement dans le sol au moyen de boulons de fondation (ou au moyen de fixations adaptées au sol en questions).
2. Insérez ensuite le parasol Inumbrina, et fixez-le en tournant la vis de réglage dans le sens des aiguilles d'une montre. Il faut que le parasol ne puisse plus tourner sur son axe. Sinon, c'est que la vis n'est pas suffisamment serrée.

UTILISATION

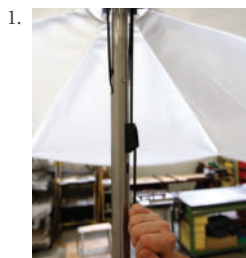

1. Pour ouvrir le parasol, tirez fermement sur la corde jusqu'à ce que la toile soit presque tout à fait à l'horizontale.
2. Vous pouvez mettre la corde dans le tube si vous pliez la corde en 2 et mettez la boucle dans le trou jusqu'à ce qu'elle soit complètement cachée.



Si vous voulez fermer le parasol, prenez la corde du tube et tenez-la légèrement inclinée. **CONSEIL:** tenez la corde inclinée jusqu'à ce que le parasol est complètement fermé.

MONTAGE INUMBRINA SUR PIED CIRCULAIRE

OUTILS



1 personne



clé Allen n° 4



+/- 20 min.

Standaard pied de parasol

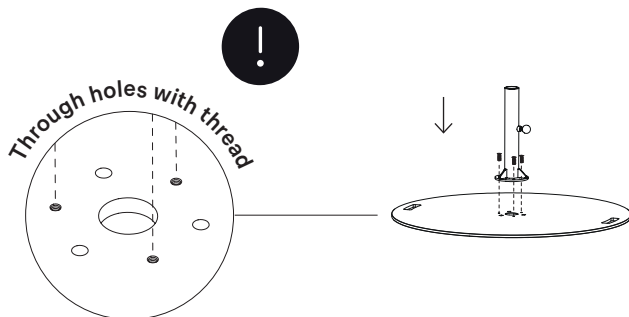

1. Place the galvanised steel base plate on the ground and mount the stainless steel tube on it with 3 bolts M6x12. Attention: Make sure that you fix the bolts in the thread of the base plate as shown on the drawing.
2. Insert the Inumbrina parasol in the anchor tube and fasten it by turning the adjusting screw clockwise. Always tighten the adjusting screw until the InUmbrina can no longer revolve on its axle.

Heavy duty pied de parasol

1. Place one of the two galvanised base plates on the ground. Then position the second base plate on top of it, make sure the square holes match the round holes with thread of the first base plate. Now place the stainless steel tube on top of the two base plates and make sure the holes of the tube match with the square holes of the second base plate. Mount the stainless steel tube on it with 3 bolts M6x20. Attention: Make sure that you fix the bolts in the thread of the first base plate as shown on the drawing!
2. Plaats vervolgens de Inumbrina parasol in de basis, en vergrendel door de stelschroef in wijzerzin te draaien. Pas als de Inumbrina niet meer rond haar as kan bewegen, is de stelschroef voldoende vastgeklemd.

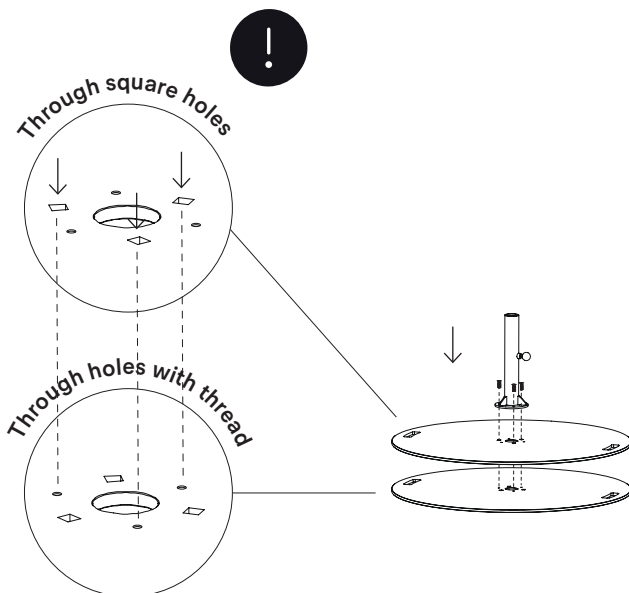

MONTAGE INUMBRINA DANS ABACHUS

OUTILS



1 personne



+/- 5 min.

Insérez ensuite le parasol Inumbrina, et fixez-le en tournant la vis de réglage dans le sens de aiguilles d'une montre. Il faut que le parasol ne puisse plus tourner sur son axe. Sinon, c'est que la vis n'est pas suffisamment serrée.

ATTENTION: Il est seulement possible de combiner le parasol Inumbrina 25 avec le Abachus.

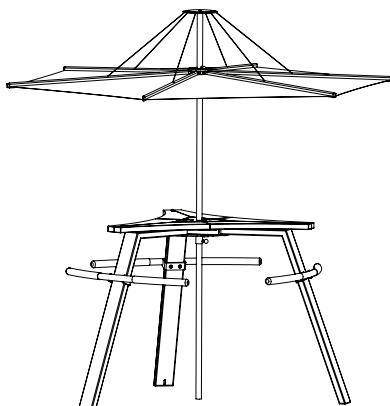

MONTAGE INUMBRINA DANS ANKER

OUTILS



1 personne



+/- 5 min.

En combinaison avec la table Anker, nous conseillons le parasol Inumbrina 32 pour faire de l'ombre.

1. Enlevez le capuchon.
2. Insérez le tube du parasol Inumbrina dans l'orifice de la table Anker et verrouillez en tournant la molette dans le sens des aiguilles d'une montre. Serrez jusqu'à ce que le parasol ne puisse plus tourner sur son axe.

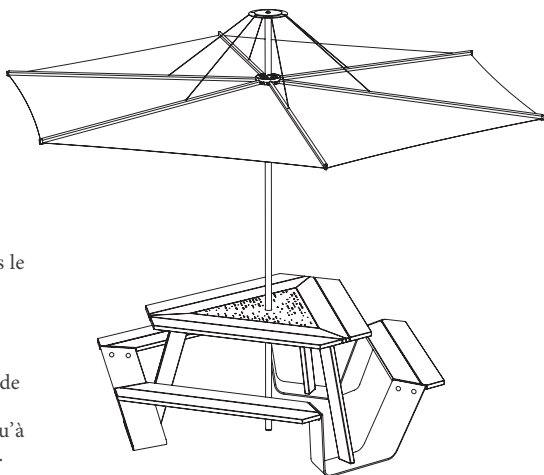

ENTRETIEN

LA TOILE

Pour nettoyer la toile du parasol et la housse, utilisez de l'eau et du savon pour les mains et frottez délicatement avec une brosse douce. Veillez à ce que le tissu du parasol ne se salisse pas exagérément, et replacez systématiquement la housse sur le parasol. le commerce.

Ne lavez jamais le parasol avec un nettoyeur haute pression.

N'utilisez pas de détergents. Ceux-ci endommagent la couche de protection du textile.

ACIER INOXYDABLE

L'acier inoxydable ne résiste pas à l'eau de mer. Surtout dans un environnement agressif (climat marin, chlore, pluie acide, environnement industriel ou urbain agressif) nous recommandons de nettoyer fréquemment la surface. Les produits appropriés pour nettoyer l'acier inoxydable sont en vente dans

AVERTISSEMENT

Lorsque vous n'utilisez pas le parasol ou par grand vent, placez la housse (en option) sur le parasol ou rentrez le parasol Inumbrina pour éviter qu'il ne s'ouvre ou ne se salisse.

Ne laissez jamais le parasol ouvert sans surveillance.

Pour des raisons de ventilation, la housse n'est pas imperméable à 100%.

Ne laissez pas Inumbrina en position fermée si la toile n'est pas tout à fait sèche. Ne laissez pas le parasol fermé pendant une longue période dans un environnement humide. Si vous utilisez pas le parasol pendant une période prolongée, rangez-le de la manière suivante: en position verticale, parfaitement sec et dans un environnement sec.

LANGUAGES

ENGLISH

contents
assembly directly to the floor
open / close inumbrina
assembly inumbrina base plate
assembly inumbrina into abachus
maintenance

NEDERLANDS

inhoud
montage grondverankering
inumbrina openen / sluiten
montage inumbrina voetplaat
montage inumbrina in abachus
onderhoud

DEUTSCH

inhalt
montage bodenverankerung
inumbrina öffnen / schließen
montage inumbrina mit bodenplatte
montage inumbrina im abachus
pflege

P. 3

p. 3
p. 4
p. 4
p. 5
p. 5
p. 7

P. 9

p. 9
p. 10
p. 10
p. 11
p. 11
p. 13

P. 15

p. 15
p. 16
p. 16
p. 17
p. 17
p. 19

FRANÇAIS

contenu
montage fixation dans au sol
ouvrier / fermer inumbrina
montage inumbrina pied circulaire
montage inumbrina dans abachus
entretien

ITALIANO

contenuto
montaggio diretto al suolo
apertura / chiusura inumbrina
montaggio inumbrina piastra di base
montaggio inumbrina con abachus
manutenzione

ESPAÑOL

contenido
montaje fijación directamente sobre el suelo
abierto / cerca inumbrina
montaje inumbrina placa de apoyo
montaje inumbrina en la mesa abachus
mantenimiento

P. 21

p. 21
p. 22
p. 22
p. 23
p. 23
p. 25

P. 27

p. 27
p. 28
p. 28
p. 29
p. 29
p. 31

P. 33

p. 33
p. 34
p. 34
p. 35
p. 35
p. 37

CONTENUTO

INUMBRINA CON FISSAGGIO DIRETTO AL SUOLO



1 x inumbrina e tubo

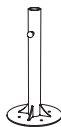

1 x tubo estensore

INUMBRINA CON PIASTRA DI BASE



1 x inumbrina e tubo

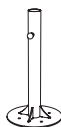

1 x tubo estensore



1 x piastra di base

INUMBRINA CON ABACHUS



1 x inumbrina e tubo

MONTAGGIO INUMBRINA CON FISSAGGIO DIRETTO AL SUOLO

NECESSARIO PER IL MONTAGGIO



1 persone



+/- 30 min.

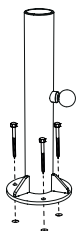

1. Posizionare il tubo inferiore in acciaio inossidabile nel punto in cui si desidera montare l'ombrellone e fissarlo al terreno con bulloni di ancoraggio (o con gli strumenti di fissaggio che meglio si adattano al tipo di terreno).
2. Inserire l'ombrellone Inumbrina nella base e bloccarlo ruotando la vite di arresto in senso orario. La vite di arresto è bloccata quando non è più possibile ruotare l'ombrellone attorno al suo asse.

UTILIZZO

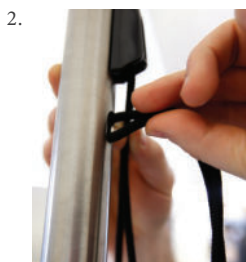
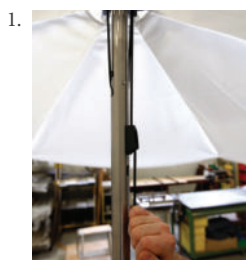

1. A questo punto si può incollare la fettuccia alla stecca così che non possa muoversi liberamente e in modo tale da non disturbare la vista.
2. Per aprire l'ombrellone, tirare la corda con decisione finché il telo non è in posizione orizzontale. Fissare la corda formando ripetutamente un otto.



Om de parasol terug te sluiten haal je het touw uit de buis en hou je deze wat schuin. **TIP:** blijf het touw schuin vasthouden tot de parasol volledig gesloten is.

MONTAGGIO INUMBRINA CON PIASTRA DI BASE

NECESSARIO PER IL MONTAGGIO



1 persone



chiave a brugola nr. 4



+/- 20 min.

Standaard base ombrellone

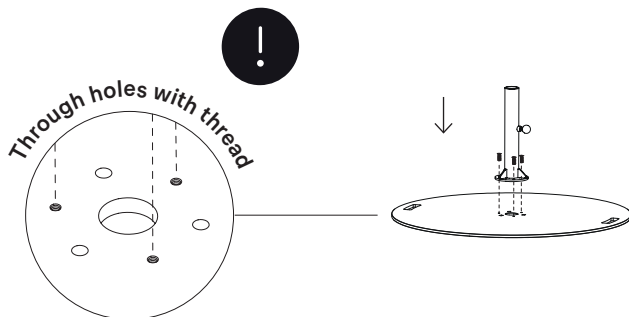

1. Place the galvanised steel base plate on the ground and mount the stainless steel tube on it with 3 bolts M6x12. Attention: Make sure that you fix the bolts in the thread of the base plate as shown on the drawing.

2. Insert the Inumbrina parasol in the anchor tube and fasten it by turning the adjusting screw clockwise. Always tighten the adjusting screw until the InUmbrina can no longer revolve on its axle.

Impieghi pesanti base ombrellone

1. Place one of the two galvanised base plates on the ground. Then position the second base plate on top of it, make sure the square holes match the round holes with thread of the first base plate. Now place the stainless steel tube on top of the two base plates and make sure the holes of the tube match with the square holes of the second base plate. Mount the stainless steel tube on it with 3 bolts M6x20. Attention: Make sure that you fix the bolts in the thread of the first base plate as shown on the drawing!

2. Plaats vervolgens de Inumbrina parasol in de basis, en vergrendel door de stelschroef in wijzerzin te draaien. Pas als de Inumbrina niet meer rond haar as kan bewegen, is de stelschroef voldoende vastgeklemd.

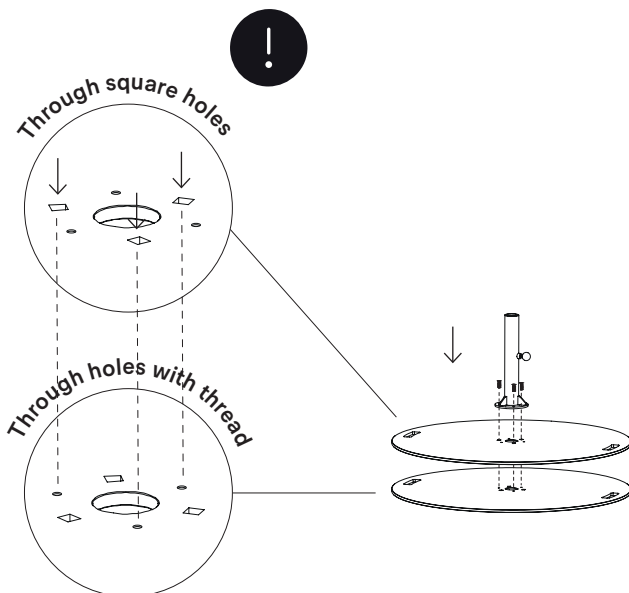

MONTAGE INUMBRINA CON ABACHUS

NECESSARIO PER IL MONTAGGIO



1 persone



+/- 5 min.

Inserire l'ombrellone Inumbrina nella base e bloccarlo ruotando la vite di arresto in senso orario. La vite di arresto è bloccata quando non è più possibile ruotare l'ombrellone attorno al suo asse.

ATTENZIONE: È possibile combinare esclusivamente Inumbrina 25 con il Abachus.

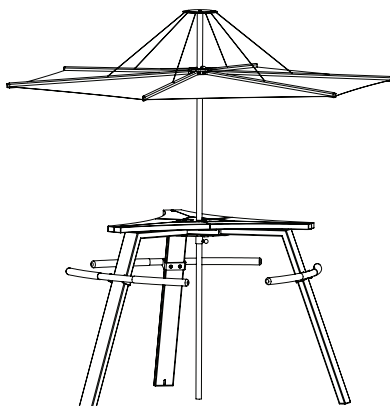

MONTAGE MONTAGGIO INUMBRINA CON ANKER

NECESSARIO PER IL MONTAGGIO



1 persone



+/- 5 min.

Con il tavolo Anker consigliamo come ombrellone il modello Inumbrina 32.

1. Rimuovere il tappo.
2. Inserire l'ombrellone Inumbrina nel tavolo Anker e bloccarlo girando la manopola in senso orario. La manopola sarà sufficientemente stretta solo quando non sarà più possibile far girare Inumbrina sul suo asse.

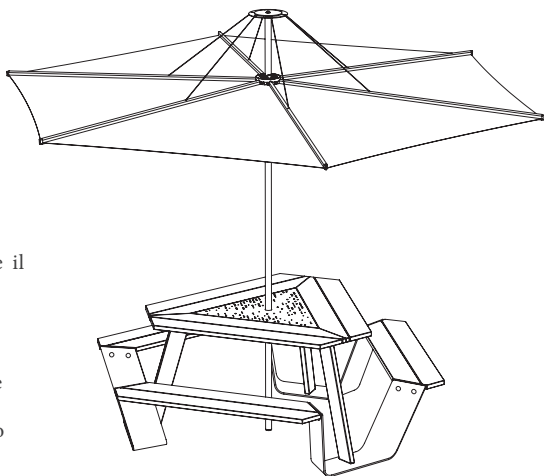

MANUTENZIONE

POLVERE

Pulire il telo dell'ombrellone e la fodera sciacquandoli con acqua e sapone per le mani sfregandoli con cura con una spazzola morbida. Evitare che il telo dell'ombrellone diventi molto sporco e ricoprirlo con la fodera il più spesso possibile.

Non pulire mai l'ombrellone con un pulitore ad alta pressione.

Non utilizzare detergenti: intaccano lo strato protettivo del tessuto.

L'ACCIAIO INOSSIDABILE

L'acciaio inossidabile non è resistente all'acqua di mare. Soprattutto in un ambiente aggressivo (clima marittimo, cloro, pioggia acida, ambiente aggressivo industriale o urbano) consigliamo di pulire regolarmente la superficie. I prodotti per pulizia adeguati sono generalmente disponibili.

AVVERTENZE

In caso di non utilizzo o vento molto forte, coprire l'ombrellone con la fodera (opzionale) o riporlo in casa per evitare che si sporchi o che si apra.

Non lasciare mai l'ombrellone incustodito quando è aperto.

Per motivi di aerazione la fodera non è impermeabile al 100%

Non lasciare chiuso Inumbrina se non è completamente asciutto. Non lasciarlo chiuso per molto tempo in condizioni di umidità.

Se non si utilizza l'ombrellone per molto tempo, riporlo come segue: in posizione verticale, asciugato perfettamente, in un luogo asciutto.

LANGUAGES

ENGLISH

contents
assembly directly to the floor
open / close inumbrina
assembly inumbrina base plate
assembly inumbrina into abachus
maintenance

NEDERLANDS

inhoud
montage grondverankering
inumbrina openen / sluiten
montage inumbrina voetplaat
montage inumbrina in abachus
onderhoud

DEUTSCH

inhalt
montage bodenverankerung
inumbrina öffnen / schließen
montage inumbrina mit bodenplatte
montage inumbrina im abachus
pflege

P. 3

p. 3
p. 4
p. 4
p. 5
p. 5
p. 7

P. 9

p. 9
p. 10
p. 10
p. 11
p. 11
p. 13

P. 15

p. 15
p. 16
p. 16
p. 17
p. 17
p. 19

FRANÇAIS

contenu
montage fixation dans au sol
ouvrier / fermer inumbrina
montage inumbrina pied circulaire
montage inumbrina dans abachus
entretien

ITALIANO

contenuto
montaggio diretto al suolo
apertura / chiusura inumbrina
montaggio inumbrina piastra di base
montaggio inumbrina con abachus
manutenzione

ESPAÑOL

contenido
montaje fijación directamente sobre el suelo
abierto / cerca inumbrina
montaje inumbrina placa de apoyo
montaje inumbrina en la mesa abachus
mantenimiento

P. 21

p. 21
p. 22
p. 22
p. 23
p. 23
p. 25

P. 27

p. 27
p. 28
p. 28
p. 29
p. 29
p. 31

P. 33

p. 33
p. 34
p. 34
p. 35
p. 35
p. 37

CONTENIDO

INUMBRINA CON FIJACIÓN DIRECTAMENTE SOBRE EL SUELO



1 x inumbrina con tubo

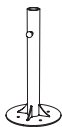

1 x palo prolongador

INUMBRINA EN PLACA DE APOYO



1 x inumbrina con tubo

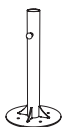

1 x palo prolongador

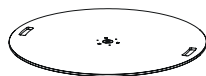

1 x placa de apoyo

INUMBRINA EN LA MESA ABACHUS



1 x inumbrina con tubo

MONTAJE INUMBRINA CON FIJACIÓN DIRECTAMENTE SOBRE EL SUELO

UTENSILOS



1 persona



+/- 30 min.

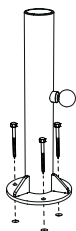

1. Coloque el tube inferior de acero inoxidable donde quiere instalar el parsol y átelo bien al suelo por medio de pernos de anclaje (o las fijaciones más aptas para su suelo).
2. Luego, coloque el parsol Inumbrina en la base y bloqueeo, girando el tornillo de ajuste en el sentido de las agujas del reloj. Cuando el Inumbrina ya no puede girar en torno a su propio eje, el tornillo de ajuste está bien cerrado.

EMPLEO

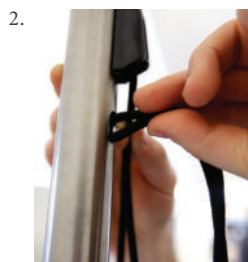
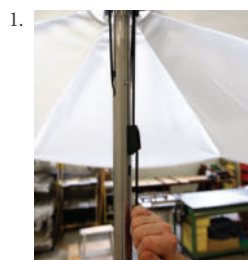

1. Ahora puede pegar la cinta contra la ballena, para que no pueda mover libremente y quitar la vista.
2. Para abrir el parsol, tire el cordón hasta que la superficie de la tela esté casi completamente horizontal. Fíjelo haciendo varios ochos.



Om de parsol terug te sluiten haal je het touw uit de buis en hou je deze wat schuin. **TIP:** blijf het touw schuin vasthouden tot de parsol volledig gesloten is.

MONTAJE INUMBRINA EN PLACA DE APOYO

UTENSILOS



1 persona



llave macho hexagonal no. 4



+/- 20 min.

Estándar base para parasol

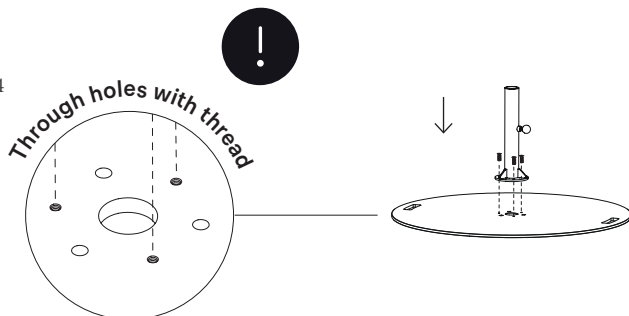

1. Place the galvanised steel base plate on the ground and mount the stainless steel tube on it with 3 bolts M6x12. Attention: Make sure that you fix the bolts in the thread of the base plate as shown on the drawing.

2. Insert the Inumbrina parasol in the anchor tube and fasten it by turning the adjusting screw clockwise. Always tighten the adjusting screw until the InUmbrina can no longer revolve on its axle.

Extrafuerte base para parasol

1. Place one of the two galvanised base plates on the ground. Then position the second base plate on top of it, make sure the square holes match the round holes with thread of the first base plate. Now place the stainless steel tube on top of the two base plates and make sure the holes of the tube match with the square holes of the second base plate. Mount the stainless steel tube on it with 3 bolts M6x20. Attention: Make sure that you fix the bolts in the thread of the first base plate as shown on the drawing!

2. Plaats vervolgens de Inumbrina parasol in de basis, en vergrendel door de stelschroef in wijzerzin te draaien. Pas als de Inumbrina niet meer rond haar as kan bewegen, is de stelschroef voldoende vastgeklemd.

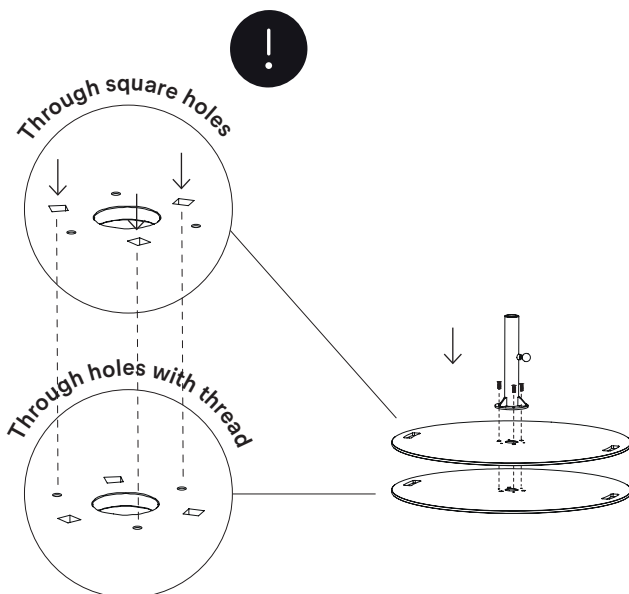

MONTAJE INUMBRINA EN LA MESA ABACHUS

UTENSILOS



1 persona



+/- 5 min.

Leugo, coloque el parasol Inumbrina en la base y bloqueeo, girando el tornillo de ajuste en el sentido de las agujas del reloj. Cuando el Inumbrina ya no puede girar en torno a su propio eje, el tornillo de ajuste está bien cerrado.

ATENCIÓN: Sólo se puede combinar Inumbrina 25 con el Abachus.

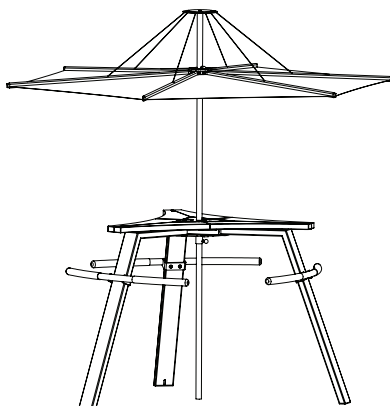

MONTAJE INUMBRINA EN LA ANKER

UTENSILOS



1 persona



+/- 5 min.

Recomendamos el parasol Inumbrina 32 como creador de sombra para la mesa de picnic Anker.

1. Quite la tapa.
2. Coloque el parasol Inumbrina en la mesa de picnic Anker y bloqueeo, girando el botón giratorio en el sentido de las agujas del reloj. Cuando el Inumbrina ya no puede girar en torno a su propio eje, el botón giratorio está bien cerrado.

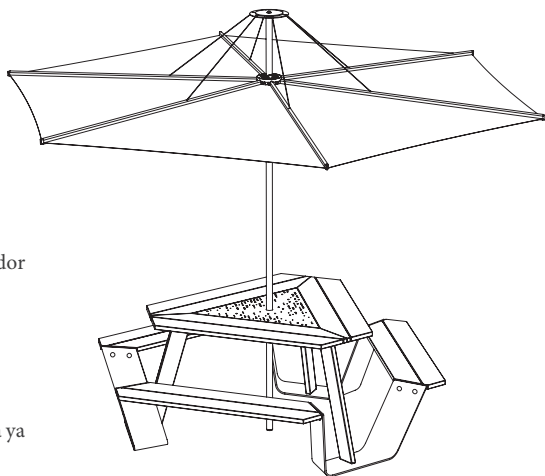

MANTENIMIENTO

POLVO

Limpie la lona del parasol y la funda lavándolos con agua y jabón y frotándolos con cuidado con un cepillo suave. Asegúrese en primera instancia que la tela del parasol no se ensucie mucho y ponga la funda sobre el parasol lo más a menudo posible.

No use nunca sistemas de inyección de agua a presión para limpiar el parasol.

No use detergentes, pues pueden perjudicar la capa protectora de la tela.

ACERO INOXIDABLE

El acero inoxidable no es resistente al agua de mar. Especialmente en un entorno agresivo (clima marítimo, cloro, lluvia ácida, entorno industrial o urbano agresivo) recomendamos la limpieza frecuente de las superficies; los productos necesarios para ello están generalmente disponibles.

CUIDADO!

Si no se emplea el parasol o cuando hay mucho viento, cubra el Inumbrina con la funda (opcional) o póngola dentro para evitar que se abra a causa del viento o que se ensucia.

No deje el parasol abierto sin vigilancia.

La funda no es 100% impermeable, a fin de que tenga ventilación.

No deje Inumbrina sin cerrar si no está completamente seco. No lo deje mucho tiempo cerrado si está húmedo.

Si no usa el parasol durante mucho tiempo, guárdelo en posición vertical, perfectamente seco, y en un lugar seco.

extremis[®]



Our headquarters:
Couthoflaan 20b
B-8972, Poperinge
info@extremis.com
+ 32 57 346020

www.extremis.com

Connect with us:



All rights reserved. Unless otherwise specified, all designs and photographs contained in this publication are copyright protected and are the property of Extremis. No part of this publication may be copied or distributed without Extremis' prior written consent. The names of the authors of photographs to which we do not hold rights are mentioned here. We have done our utmost to provide a comprehensive list of names. In the event of an alleged breach, please contact the editorial staff. © Extremis

20200630