

# Panigiri

© design by Dirk Wynants

extremis®



## Dimensions

The Panigiri combo base module

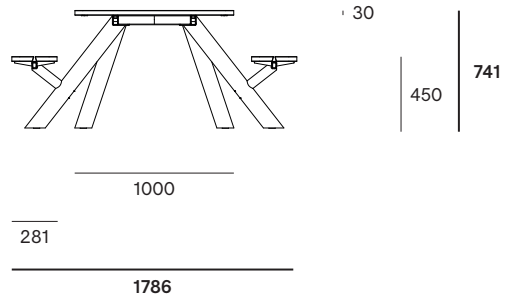
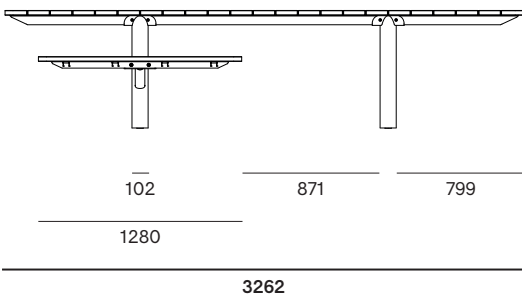
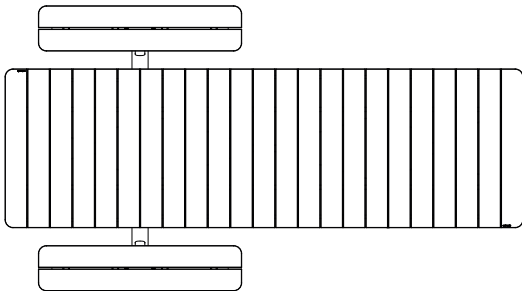

The Panigiri picnic base module

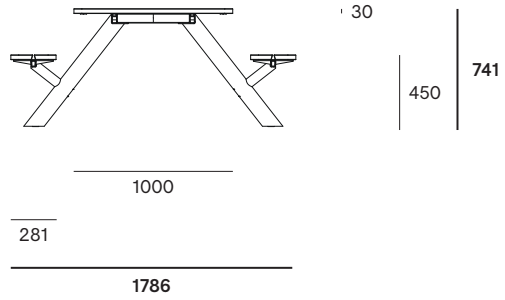
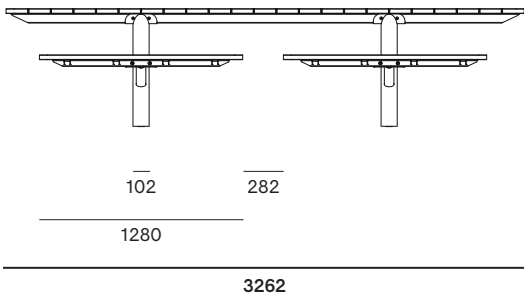
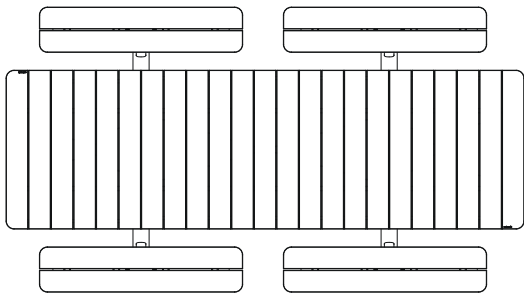

The Panigiri table base module

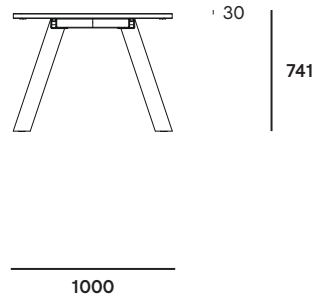
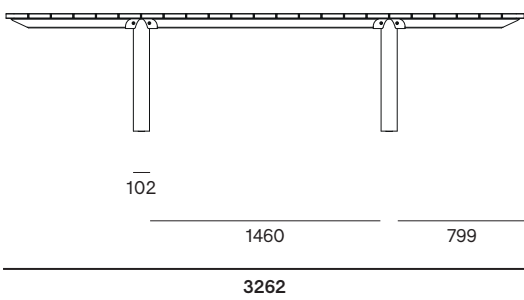
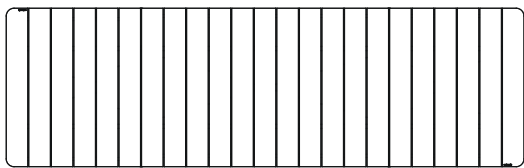

# Box dimensions

Box 1: Tabletop centerframe

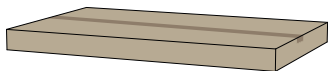

Box 2: Tabletop endframes

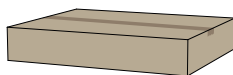

Box 3: Picnic legs



Box 4: Benches



Box 5: Table legs



The [Panigiri combo](#) base module comes in 5 boxes

Box dimensions (mm)		L	W	H	Qty	Volume (m3)	Gross weight (kg)	Net weight (kg)	Packaging weight (kg)
<b>Panigiri combo</b>	Box 1	1705	1040	125	1	0,22	54,00	48,50	5,50
Base module	Box 2	1130	910	200	1	0,21	54,00	48,80	5,20
	Box 3	975	500	225	1	0,11	20,20	16,20	4,00
	Box 4	1330	340	215	1	0,10	24,30	20,40	3,90
	Box 5	910	360	190	1	0,06	15,00	11,40	3,60
Total:						<b>0,70</b>	<b>167,50</b>	<b>145,30</b>	<b>22,20</b>

The [Panigiri picnic](#) base module comes in 4 boxes

Box dimensions (mm)		L	W	H	Qty	Volume (m3)	Gross weight (kg)	Net weight (kg)	Packaging weight (kg)
<b>Panigiri picnic</b>	Box 1	1705	1040	125	1	0,22	54,00	48,50	5,50
Base module	Box 2	1130	910	200	1	0,21	54,00	48,80	5,20
	Box 3	975	500	225	2	0,22	40,40	32,40	8,00
	Box 4	1330	340	215	2	0,20	48,60	40,80	7,80
Total:						<b>0,85</b>	<b>197,00</b>	<b>170,50</b>	<b>26,50</b>

The [Panigiri table](#) base module comes in 3 boxes

Box dimensions (mm)		L	W	H	Qty	Volume (m3)	Gross weight (kg)	Net weight (kg)	Packaging weight (kg)
<b>Panigiri table</b>	Box 1	1705	1040	125	1	0,22	54,00	48,50	5,50
Base module	Box 2	1130	910	200	1	0,21	54,00	48,80	5,20
	Box 5	910	360	190	2	0,12	30,00	22,80	7,20
Total:						<b>0,55</b>	<b>138,00</b>	<b>120,10</b>	<b>17,90</b>

## Additional picnic module

The additional picnic module is available in one dimension

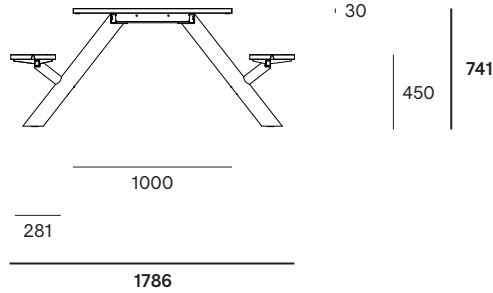
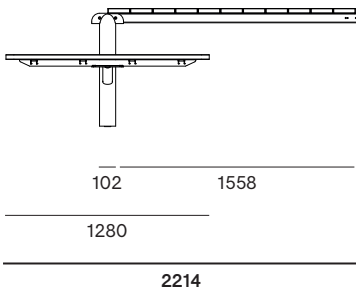
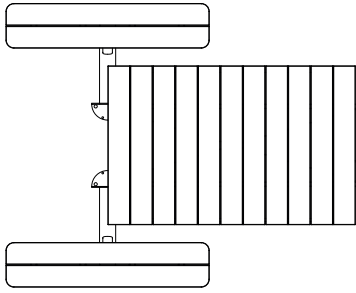

## Additional picnic module box dimensions

The additional picnic module comes in 3 boxes

Box 1: Tabletop centerframe

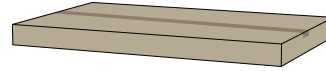

Box 3: Picnic legs



Box 4: Benches



Box dimensions (mm)		L	W	H	Qty	Volume (m <sup>3</sup> )	Gross weight (kg)	Net weight (kg)	Packaging weight (kg)
Additional picnic module	Box 1	1705	1040	125	1	0,22	54,00	48,50	5,50
	Box 3	975	500	225	1	0,11	20,20	16,20	4,00
	Box 4	1330	340	215	1	0,10	24,30	20,40	3,90
					Total:	<b>0,43</b>	<b>98,50</b>	<b>85,10</b>	<b>13,40</b>

## Additional table module

The additional table module is available in one dimension

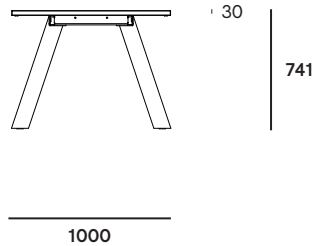
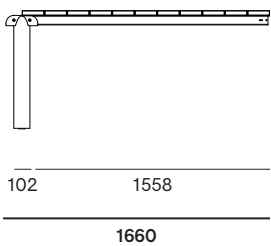
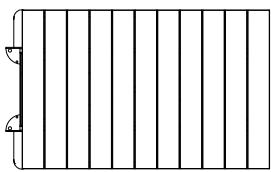

## Additional table module box dimensions

The additional table module comes in 3 boxes

Box 1: Tabletop centerframe

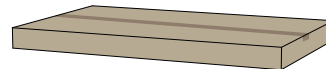

Box 5: Table legs



Box dimensions (mm)		L	W	H	Qty	Volume (m <sup>3</sup> )	Gross weight (kg)	Net weight (kg)	Packaging weight (kg)
Additional table module	Box 1	1705	1040	125	1	0,22	54,00	48,50	5,50
	Box 5	910	360	190	1	0,06	15,00	11,40	3,60
					Total:	<b>0,28</b>	<b>69,00</b>	<b>59,90</b>	<b>9,10</b>

## Panigiri combo + additional modules

Add the additional picnic module, on the right or on the left (between center and endframe)



Add the additional table module, on the right or on the left (between center and endframe)

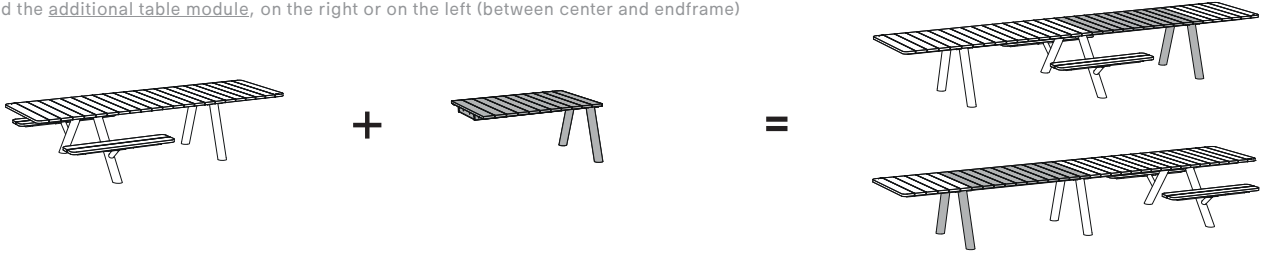

## Panigiri picnic + additional modules

Add the additional picnic module, on the right or on the left (between center and endframe)

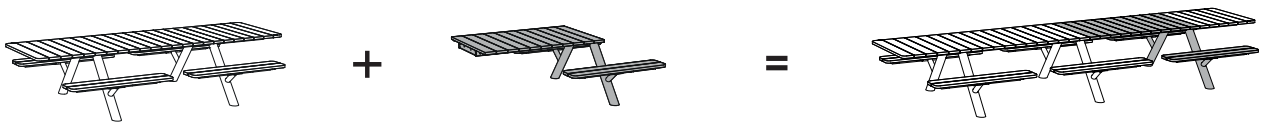

Add the additional table module, on the right or on the left (between center and endframe)

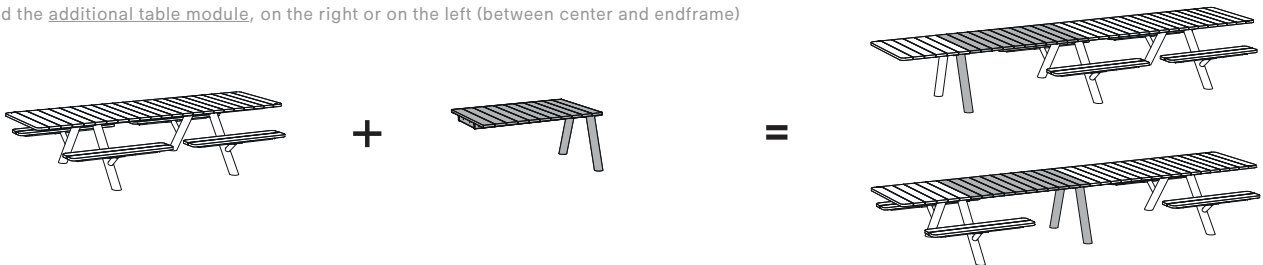

## Panigiri table + additional modules

Add the additional picnic module, on the right or on the left (between center and endframe)

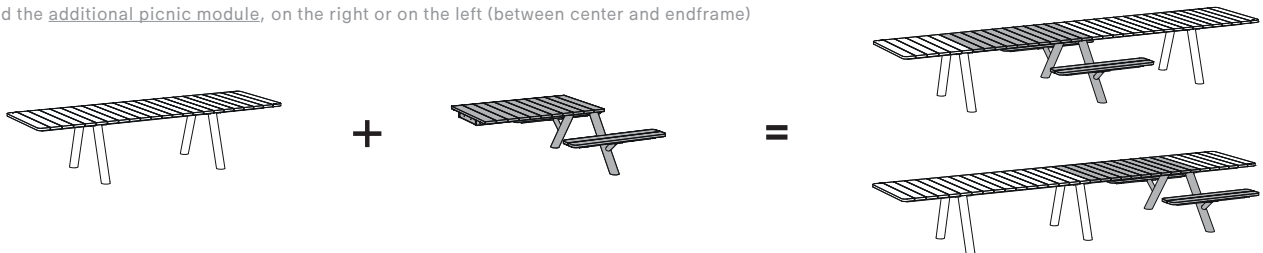

Add the additional table module, on the right or on the left (between center and endframe)

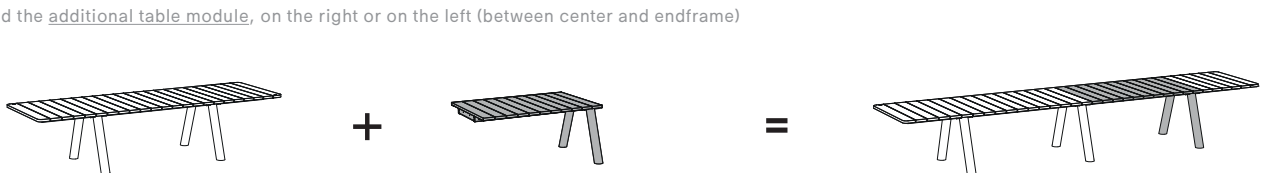

# Endless modularity

Mix and match benches and chairs to create your desired setup, the modular design creates different seating options  
Below some predefined combinations

**326 cm**  
8 people  
(4 to 6 Captain's Chairs)

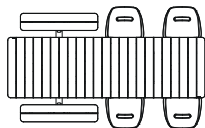

**482 cm**  
12 people  
(4 to 6 Captain's Chairs)

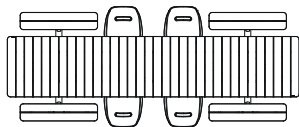

**482 cm**  
12 people  
(4 to 6 Captain's Chairs)

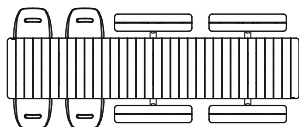

**638 cm**  
16 people  
(4 to 6 Captain's Chairs)

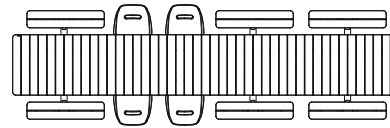

**638 cm**  
16 people  
(8 to 10 Captain's Chairs)

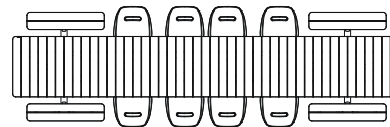

**794 cm**  
20 people  
(8 to 10 Captain's Chairs)

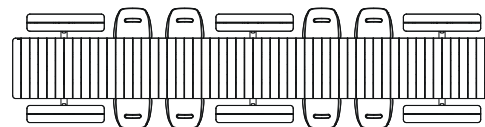

**326 cm**  
8 people

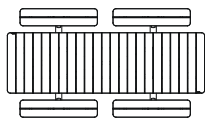

**638 cm**  
16 people

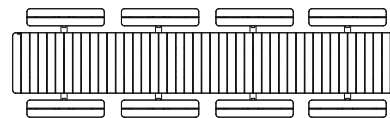

**482 cm**  
12 people

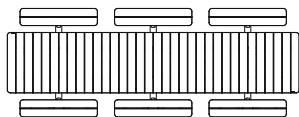

**794 cm**  
20 people

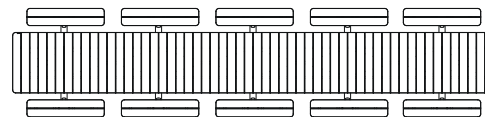

**326 cm**  
(8 to 10 Captain's Chairs)

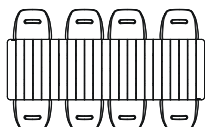

**638 cm**  
(16 to 18 Captain's Chairs)

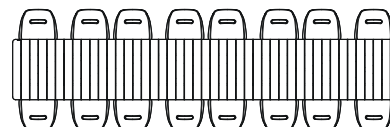

**482 cm**  
(12 to 14 Captain's Chairs)

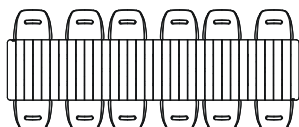

**794 cm**  
(20 to 22 Captain's Chairs)

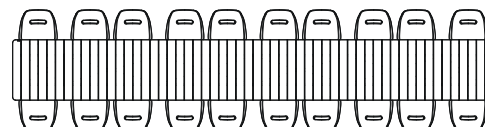

## BYOS

The BYOS seat is available in one dimension

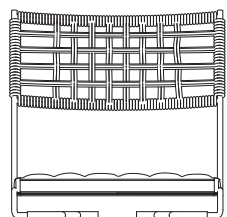
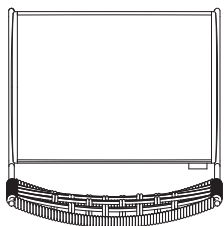

453

474

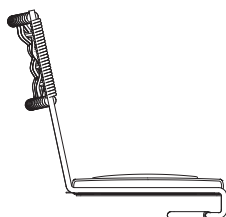

331

483

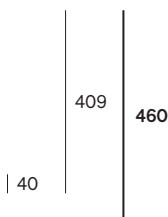

## BYOS box dimensions

The BYOS seat comes in 1 box

Box 6: BYOS

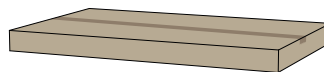

Box dimensions (mm)		L	W	H	Qty	Volume (m3)	Gross weight (kg)	Net weight (kg)	Packaging weight (kg)
BYOS (x1)	Box 6	665	500	270	1	0,09	7,82	4,82	3,00
BYOS (x2)	Box 6	665	500	320	1	0,11	12,64	9,64	3,00

## Slide-on cushion

The Slide-on cushion is available in one dimension



255

510



43 | 60

259

## Slide-on cushion box dimensions

The Slide-on cushion comes in 1 box

Bag 1: Slide-on cushion

Box dimensions (mm)		L	W	H	Qty	Volume (m3)	Gross weight (kg)	Net weight (kg)	Packaging weight (kg)
Slide-on cushion	Bag 1	510	259	60	1	0,01	0,35	0,34	0,01

# Wheelchair accessibility dimensions

As specifications for wheelchair accessibility vary around the world, please review the dimensions below to ensure the measurements of each solution meet the specifications of your local requirements

Accessible on sides  
with no benches



Accessible on  
both ends

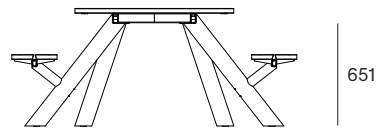
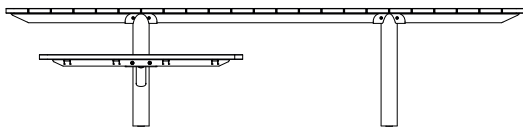
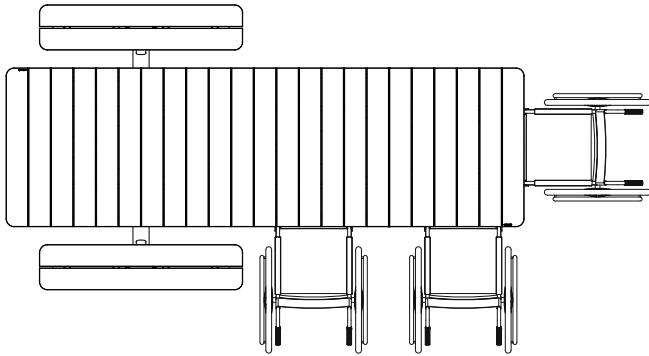

1224



# Materials & colors

Check price list or [www.extremis.com](http://www.extremis.com) for current materials & colors

## Tabletop & benches



Hellwood

## Frame



Galvanized steel

## Sunbrella® cushions

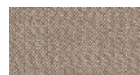

Coconut  
Sunbrella Savane



Marble  
Sunbrella Lopi

## BYOS frame



Earth  
Structured powder coating

## Legs



Black (RAL9005)  
Structured powder coating



Earth  
Structured powder coating



Beach beige (RAL1019)  
Structured powder coating



Off white (RAL9002)  
Structured powder coating



Materials	Key facts	Thickness	Layer thickness	Density	In/outdoor	Water	UV color fastness	Flame retarding
		mm	micron					
Hellwood tabletop & benches	 <ul style="list-style-type: none"> <li>Durability CLASS 1</li> <li>Carries the PEFC™ label for durable forestry</li> <li>Feels comfortable in all weather conditions</li> <li>Advisable to oil the wood</li> </ul>	30	n.a.	600 kg/m <sup>3</sup>	Outdoor & indoor	n.a.	Untreated wood turns grey after a while	/
Hot dip galvanized steel frame	<ul style="list-style-type: none"> <li>Most durable method for protecting metal from rusting</li> <li>Protective layer</li> <li>Very long life span</li> <li>100% recyclable</li> <li>Cradle to Cradle Certified™</li> </ul>	2 - 6	50 - 100	7,50 10 <sup>3</sup> kg/m <sup>3</sup>	Outdoor & indoor	n.a.	Very good, galvanization will however become less shiny when used outdoors	NEN-EN13501-1 A1 *
Structured powder coated stainless steel legs	<ul style="list-style-type: none"> <li>Easy to clean</li> <li>Stainless steel (for protection against rust), then powder-coated</li> <li>More scratch-resistant than non structured powder-coating</li> </ul>	2	50 - 100	8,00 10 <sup>3</sup> kg/m <sup>3</sup>	Outdoor & indoor	n.a.	Very good: color can fade to some extent when exposed to UV	NEN-EN13501-1 A1 *
Sunbrella® cushions	<ul style="list-style-type: none"> <li>100% Sunbrella Acrylic</li> <li>Best outdoor fabric available for making cushions</li> <li>Dirt repellent</li> <li>Not waterproof, store inside!</li> <li>Machine washable at max. 30°C. Ironing restores the protective layer</li> </ul>	0,50	n.a.	260 g/m <sup>2</sup>	Outdoor & indoor	The fabric has a water column of 350 mm (EN 20811)	7/8 (ISO 105-B02)	/
Structured powder coated zinc steel BYOS frame	<ul style="list-style-type: none"> <li>Easy to clean</li> <li>Electro galvanized (for extra protection against rust), then powder coated</li> <li>More scratch-resistant than non structured powder coating</li> </ul>	3	100	7,50 10 <sup>3</sup> kg/m <sup>3</sup>	Outdoor & indoor	n.a.	Very good: color can fade to some extent when exposed to UV	NEN-EN13501-1 A1 *
Polypropylene cord	<ul style="list-style-type: none"> <li>100% recyclable</li> <li>High tenacity yarn</li> </ul>	6	n.a.	n.a.	Outdoor & indoor	n.a.	7/8 (ISO 105-B02)	/

### NEN-EN13501-1 A1

Class A1 products will not contribute to fire in any stage, including fully developed fire. For this reason, they are assumed to be capable of satisfying all requirements of all lower classes as well.

## Good to know

- PEFC™ certified wood originates from sustainably managed forests.
- BYOS stands for "Bring Your Own Seat"
- Intelligent design: 4 # elements, endless modularity.
  1. Center top (x 1, 2, 3, 4, ... endless)
  2. End top
  3. Table leg
  4. Picnic leg (with bench)



- Panigiri combines perfectly with Sensu tilted.



## F.A.Q.

Q: Do you need to oil the wood?

A: Just like other types of wood, wood will gradually become rougher and start to turn grey as a consequence of exposure to the sun and rain. Small cracks and crevices can also appear as part of this process. We strongly advise everyone to treat the furniture with our Wood Protector. This 100% natural oil controls the moisture level within the wood, which makes the planks stay stable for longer, and the layer of oil also helps to prevent spilled liquids from being absorbed, so that stains tend to stay superficial. It is best to repeat this treatment at regular intervals.

## Maintenance

### POWDER COATED PARTS

- White powder coating obviously requires more maintenance.

### GALVANIZED PARTS

- Clean with lukewarm water and a mild detergent or Extremis multi cleaner.

### WOOD



- Clean regularly with mild detergent.
- Thorough cleaning with Extremis Wood Cleaner.
- Oil the wood with Extremis Wood Protector. We recommend oiling the wood at regular intervals depending from location and general weather conditions.
- In order to smoothen the surface again after a thorough cleaning, lightly sand your wood with 120 grit sanding paper or a sanding pad.

### SUNBRELLA

- Shake or brush off loose dirt immediately.
- Spray Extremis Multi Cleaner.
- Use a soft brush and make circular movements.
- Let the suds soak in for a moment.
- Rinse thoroughly to remove all soap residue.
- Simply allow to dry.
- It's also possible to put the blanket and the pillow covers in a washing machine (max 40°C). Follow the cleaning instruction on the label.
- If the cushion has metal brackets, we recommend turning the cover inside out first to avoid damaging the washing machine. In this case, leave the zipper open about 10 cm.

### RECOMMENDED USE

- For Extremis Wood protector:

 1L	 0.5L	
2 to 3 wood care treatments	1 to 2 wood care treatments	300 - 400 ml for one Panigiri combo
1 to 2 wood care treatments	1 wood care treatment	350 - 500 ml for one Panigiri picnic
5 to 7 wood care treatments	2 to 3 wood care treatments	300 - 400 ml for one Panigiri table

## Certificates

- PEFC
- Cradle to Cradle

## Warnings

### General

- Do not use any sharp tools to open the packaging.
- We strongly advise against using power tools.
- Tripping hazard, mind your step.
- Do not put out cigarettes on the table.
- Not graffiti proof.
- Do not leave children unattended whilst playing on the table.
- To avoid danger of suffocation, keep plastic bags away from babies and children.
- Colors can differ over years and from batch to batch.

### Product

- Do not stand or jump on the table.
- Do not drag the table, but carry it with minimum 2 people.
- Max. 2 people or 240 kg per bench.

### Wood

- When delivered, the wood is untreated.
- Wood is a natural material and its look is different for every slat, plank and tree.
- Wood will gradually become rougher and start to turn grey as a consequence of exposure to the sun

and rain. We recommend oiling the wood at regular intervals depending from location and general weather conditions.

- Clean regularly with mild detergent. Never use a high pressure cleaner as this will roughen the wood's smooth surface and irreparably damage the wood's fiber.
- Thorough cleaning with Extremis Wood Cleaner.
- We strongly recommend that you treat your wood with wood protector to protect it from stains - small cracks and crevices can also appear as part of this process. We strongly advise everyone to treat the furniture with our Wood Protector.

### Powder coating

- White powder coating requires more maintenance.
- Do not use abrasive scouring powders or scourers as they will scratch the surface.
- Color can fade to some extent when exposed to UV.
- Flame retarding - NEN-EN13501-1 A2-sl - Satisfying the same criteria as Class B for the SBI-test according to EN13823. In addition, under conditions of a fully developed fire these products will not significantly contribute to the fire load and fire growth.

- Dark colors can get very hot in sunny weather.

### Galvanized steel

- Galvanization will become less shiny when used outdoors.
- Flame retarding - NEN-EN13501-1 A1 - Class A1 products will not contribute to fire in any stage, including fully developed fire. For this reason, they are assumed to be capable of satisfying all requirements of all lower classes as well.
- Possible impurities in the immersion tank can cause black marks during galvanization, which are intrinsic to this industrial finishing technique.
- White marks on this zinc layer are also intrinsic to this procedure and will disappear when the furniture is put outdoors.
- This industrial finishing technique may result in a rougher surface. This is intrinsic to the process.

### Sunbrella®

- Not waterproof, store inside!
- Shake or brush off loose dirt immediately.
- UV color fastness: 7/8 (ISO 105-B02).