



Tisch mit Platte bestehend aus verleimten Massivholzleisten, mit geraden Kanten. Gestell aus Eisen.

**STANDARD VERSION: UNTERGESTELL AUS EISEN IRONDUST LACKIERT (B2)**

ART.NR.	MASS	GESTELL	A1	A2	A4
<b>NATURA-TAV NEWTON1</b>	L.160 x T.90 x H.75	B2	■	■	■
		B3	■	■	■
<b>NATURA-TAV NEWTON2</b>	L.180 x T.90 x H.75	B2	■	■	■
		B3	■	■	■
<b>NATURA-TAV NEWTON3.1</b>	L.200 x T.100 x H.75	B2	■	■	■
		B3	■	■	■
<b>NATURA-TAV NEWTON4</b>	L.220 x T.100 x H.75	B2	■	■	■
		B3	■	■	■
<b>NATURA-TAV NEWTON5</b>	L.240 x T.100 x H.75	B2	■	■	■
		B3	■	■	■
<b>NATURA-TAV NEWTON6</b>	L.260 x T.100 x H.75	B2	■	■	■
		B3	■	■	■
<b>NATURA-TAV NEWTON7</b>	L.280 x T.100 x H.75	B2	■	■	■
		B3	■	■	■
<b>NATURA-TAV NEWTON8</b>	L.300 x T.100 x H.75	B2	■	■	■
		B3	■	■	■

**VERFÜGBARE AUSFÜHRUNGEN:**

- A1:** Nussbaum ohne Knoten, Nussbaum mit Knoten
- A2:** Eiche ohne Knoten, Eiche mit Knoten, Kirschbaum, Ahorn
- A4:** Eiche ohne Knoten pigmentiert: total black  
Eiche mit Knoten pigmentiert: total black
- B2:** Eisen lackiert: irondust, RAL (nur ausgewählte Farben)
- B3:** Eisen lackiert, Effekt matt gebürstet: Bronze antik, Edelstahl, Titan

DETAIL: PLATTE MIT GERADEN KANTEN

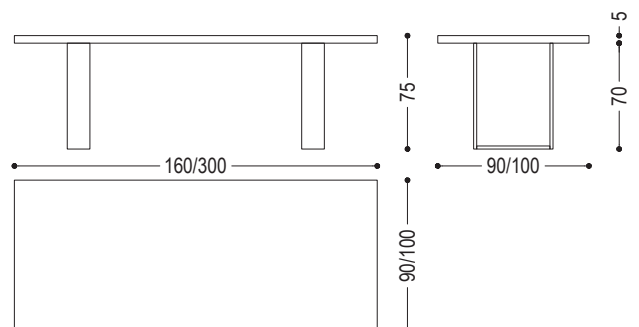

## HOLZ

A1



Nussbaum ohne Knoten



Nussbaum mit Knoten

A2



Eiche ohne Knoten



Eiche mit Knoten



Kirschbaum



Ahorn

A4

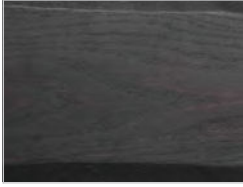







Eiche ohne Knoten pigmentiert:  
total black

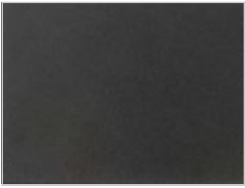

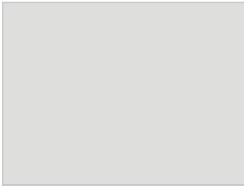
Eiche mit Knoten pigmentiert:  
total black

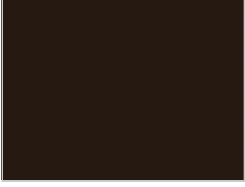
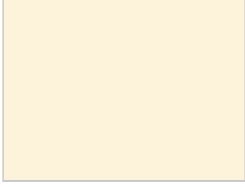
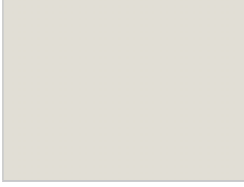
## EISEN

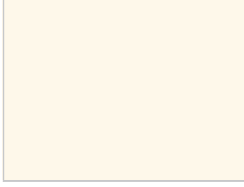
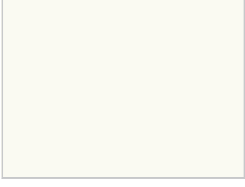
B2					
					
					
B3	